

Servomotors

K Series Kit - CE Certified

Technical Manual
PVD 3674_GB





EU DECLARATION OF CONFORMITY

We ,

Parker Hannifin Manufacturing France SAS
Electromechanical & Drives Division Europe
Etablissement de Longvic
4 Boulevard Eiffel - CS40090
21604 LONGVIC Cedex - France

manufacturer, with brand name **Parker**, declare under our sole responsibility that the products

SERVOMOTORS TYPE K

satisfy the arrangements of the directives :

Directive 2014/35/EU : “Low Voltage Directive”, LVD
Directive 2011/65/EU : “Restriction of Hazardous Substances”, RoHS
Directive 2014/30/EU : “Electromagnetic Compatibility”, EMC

and meet standards or normative document according to :

EN 60034-1:2010/AC:2010 : Rotating electrical machines - Part 1 : Rating and performance.
EN 60034-5:2001/A1:2007 : Rotating electrical machines - Part 5 : Degrees of protection provided by the integral design of rotating electrical machines (IP code) - Classification.
EN 60204-1:2006/AC:2010 : Safety of machinery – Electrical equipment of machines – Part 1 : General requirements.

The undersigned certify that the above mentioned model is procured in accordance with the above directives and standards.

Further information :

Kit K shall be mounted on a mechanical support providing good heat conduction and not exceeding 40° C in the vicinity of the motor flange.

As K Series are the active parts of an incomplete motor, the design, the construction, the certification and the final conformance of the complete motor is under the responsibility of the integrator.

The product must be installed in accordance with the instructions and recommendations contained in the operating instructions supplied with the product.

C.E. Marking : October 2015

Longvic, November 18th 2016

Ref : DCE-K-001rev0

In the name of Parker
A. ANDRIOT
Quality Manager

Table of Content

1. INTRODUCTION	5
1.1. Purpose and intended audience	5
1.2. Safety	5
1.2.1. Principle.....	5
1.2.2. General Safety Rules	6
2. PRODUCT DESCRIPTION	7
2.1. Quick URL.....	7
2.2. Overview	7
2.3. Applications	7
2.4. Motor description.....	8
2.5. General Technical Data	9
2.6. Product Code	10
3. TECHNICAL DATA	11
3.1. Kit selection	11
3.1.1. Altitude derating.....	11
3.1.2. Temperature derating	11
3.1.3. Thermal equivalent torque (rms torque)	12
3.1.4. Kit Selection.....	13
3.1.5. Current limitation at stall conditions (i.e. speed < 3 rpm)	16
3.1.6. Peak current limitations	16
3.2. K Characteristics: Torque, speed, current, power	17
3.2.1. Voltage withstand characteristics	17
3.2.2. Torque, Speed, Current characteristics.....	17
3.2.3. K datas – DC bus voltage 12VDC	18
3.2.4. K datas – DC bus voltage 24VDC	19
3.2.5. K datas – DC bus voltage 48VDC	20
3.2.6. K datas – DC bus voltage 96VDC	21
3.2.7. K datas – Power voltage 240VAC	22
3.2.8. Further Data	23
3.2.9. Electromagnetic losses.....	24
3.2.10. Electric time constant & Mechanical time constant	25
3.3. Dimension drawings	26
3.3.1. K032 - Stator	26
3.3.2. K032 - Rotor	27
3.3.3. K032 – Stator with Hall effect sensor	28
3.3.4. K032 – Rotor with magnets for Hall effect sensor	29
3.3.5. K044	30
3.3.6. K044 – with Hall effect sensor	31
3.3.7. K064	32
3.3.8. K064 – with Hall effect sensor	33
3.3.9. K089	34
3.3.10. K089 – with Hall effect sensor	35
3.3.11. K178	36
3.4. Motor mounting recommendations	37
3.4.1. Frame recommendations.....	37
3.4.2. Servomotor typical construction	38
3.4.3. Bearings recommendation	38
3.4.4. Mounting recommendations	38
3.4.5. Design Compliance	43
3.4.6. Dielectric test	43
3.4.7. Earthing	43
3.4.8. Minimum clearances for insulation and creepage distances.....	43
3.4.9. Ground continuity compliance	44
3.4.10. Protection rating	44
3.4.11. Overspeed test	45
3.4.12. EMC Directive.....	45



3.4.13.	Other regulation requirements.....	45
3.5.	Natural cooled motor.....	46
3.6.	Power Electrical Connections	47
3.6.1.	Wires sizes	47
3.6.2.	Conversion Awg/kcmil/mm ² :.....	48
3.6.3.	Motor cable length	49
3.6.4.	Ground connection	49
3.6.5.	Motor cable	49
3.6.6.	Motor Lead Cross Section [Awg].....	50
3.7.	Feedback system	51
3.7.1.	Commutation Hall effect sensor	51
3.7.2.	Resolver	52
3.7.3.	Encoder	57
4.	COMMISSIONING, USE AND MAINTENANCE	58
4.1.	Instructions for commissioning, use and maintenance	58
4.1.1.	Equipment delivery	58
4.1.2.	Handling	58
4.1.3.	Storage	58
4.2.	Kit Integration	59
4.2.1.	General warnings	59
4.2.1.	Tightening torque.....	60
4.3.	Electrical connections	61
4.4.	Commutation sensor cable handling.....	63
4.5.	Tests.....	64
4.6.	Troubleshooting	65

Lexicon in use

Kit: Active parts delivered by Parker

Motor: Active parts integrated into a mechanical assembly providing the means of rotating, designed, assembled, certified and tested according to the relevant directives, standard, regulation for the motor application

Integrator: Person who purchases the K active parts and designs, assemblies, certifies tests the motor according to the relevant directives, standard, regulation for the motor application and defines the relevant directives, standard, regulation for the motor application

1. INTRODUCTION

1.1. Purpose and intended audience

This manual contains information that must be observed to select, install, operate and maintain PARKER K Series Kit.

The design, tests, certification, commissioning, operation and maintenance of the equipment should be carried out by qualified personnel. A qualified person is someone who is technically competent and familiar with all safety information and established safety practices; with the installation process, operation and maintenance of this equipment; and with all the hazards involved.

Reading and understanding the information described in this document is mandatory before carrying out any operation on the motors. If any malfunction or technical problem occurs, that has not been dealt with in this manual, please contact PARKER for technical assistance. In case of missing information or doubts regarding the installation procedures, safety instructions or any other issue tackled in this manual, please contact PARKER as well.

PARKER's responsibility is limited to its servomotors in kit and does not encompass the kit integration, the certification of the complete motor or the whole user's system. Data provided in this manual are for product description only and may not be guaranteed, unless expressly mentioned in a contract.



DANGER: PARKER declines responsibility for any accident or material damage that may arise, if the procedures and safety instructions described in this manual are not scrupulously followed.

1.2. Safety





1.2.1. Principle

To operate safely, this equipment must be transported, stored, handled, installed and serviced correctly. Following the safety instructions described in each section of this document is mandatory. Servomotors usage must also comply with all applicable standards, national directives and factory instructions in force.



DANGER: Non-compliance with safety instructions, legal and technical regulations in force may lead to physical injuries or death, as well as damages to the property and the environment.

1.2.2. General Safety Rules

	<p>Generality DANGER: The installation, commission and operation must be performed by qualified personnel, in conjunction with this documentation.</p> <p>The qualified personnel must know the safety (C18510 authorization, standard VDE 0105 or IEC 0364), the standard to comply with the low directive and the EMC directive and local regulations such as Machinery Directive 2006/42/EC</p> <p>They must be authorized to install, commission and operate in accordance with established practices and standards.</p>
	<p>Electrical hazard Servo drives may contain non-insulated live AC or DC components. Respect the drives commissioning manual. Users are advised to guard against access to live parts before installing the equipment.</p> <p>Some parts of the kit, the motor or installation elements can be subjected to dangerous voltages, when the motor is driven by the inverter , when the motor rotor is manually rotated, when the motor is driven by its load, when the motor is at standstill or stopped.</p> <p>For measurements use only a meter to IEC 61010 (CAT III or higher). Always begin using the highest range. CAT I and CAT II meters must not be used on this product.</p> <p>Allow at least 5 minutes for the drive's capacitors to discharge to safe voltage levels (<50V). Use the specified meter capable of measuring up to 1000V DC & AC rms to confirm that less than 50V is present between all power terminals and between power terminals and earth.</p> <p>Check the drive recommendations. The motor must be permanently connected to an appropriate safety earth. To prevent any accidental contact with live components, it is necessary to check that cables are not damaged, stripped or not in contact with a rotating part of the machine. The work place must be clean, dry.</p> <p>General recommendations :</p> <ul style="list-style-type: none"> - Check the wiring circuit - Lock the electrical cabinets - Use standardized equipment
	<p>Mechanical hazard Servomotors can accelerate in milliseconds. Running the motor can lead to other sections of the machine moving dangerously. Moving parts must be screened off to prevent operators coming into contact with them. The working procedure must allow the operator to keep well clear of the danger area.</p>
	<p>Burning Hazard Always bear in mind that the motor surface temperature can exceed 100°C.</p>

2. PRODUCT DESCRIPTION

2.1. Quick URL

All informations and data are available on :

<http://www.parker.com/eme/k>

2.2. Overview

The K frameless servomotor are the active parts of a servo motor: a rotor and a stator. The K series can not be used alone and must integrated into a complete system to provide a complete servomotor. The design, the construction, the certification and the tests are the responsibility of the integrator.

K Series Kit from PARKER is an innovative direct drive solution designed for industrial applications. K Series Kit from Parker combine exceptional precision and motion quality, high dynamic performances, very compact dimensions and large hollow shaft. A large set of torque / speed characteristics, options and customization possibilities are available, making K Series Kit the ideal solution for most servosystems applications.

Advantages

- Low voltage
- Compact dimensions and robustness
- Large hollow shaft
- Direct drive: accurate and dynamic motion
- Integrated Hall Effect sensor as an option
- Higher stiffness of the system
- Simple, light and compact machine design
- no coupling systems needed
- Global cost reduction
- Increased reliability and reduced maintenance
- Integration assistance

2.3. Applications

Medical: Blood pumps, air pump, radiology tables,...

Hand tool: screwdriver,...

Packaging machinery

Special machines

Rotating tables

Compressor

Pump

Partner of your integration :

- ✓ Flexible organization and technical know-how
- ✓ Assistance during mechanical integration
- ✓ Assistance during mechanical system tuning

2.4. Motor description



Design Features

- ① Pre-installed integral commutation board with Hall effects is prealigned for easy assembly. Motor and feedback as integrated unit.
- ② Rare earth magnets provide high-flux in a small volume, high resistance to thermal demagnetizing.
- ③ Rotor assembly for easy mounting directly on the drive shaft with or without keyway.
- ④ Machined grooves to securely lock magnets to rotor and ensures optimized radial location.
- ⑤ Class H insulation for high-temperature operation (up to 155°C) meeting UL approved requirements.
- ⑥ High-density copper winding for low thermal resistance and consistent performance across all motors.
- ⑦ Minimized end turns to maximize performance. Formed to minimize motor size.
- ⑧ Skewed laminations with odd slot counts reduce cogging for precise rotary motion with drastically reduced torque ripple even at low speeds.
- ⑨ Optimized slot fill for maximum torque-to-size ratio; hand inserted to obtain highest slot fill possible maximizing ampere-turns.

2.5. General Technical Data

Motor type	Permanent-magnet synchronous motor												
Magnet material	Nd-Fe-B (Neodymium Iron Boron)												
Number of poles	<table border="1"> <tr> <td>Size:</td> <td>K032</td> <td>K044</td> <td>K064</td> <td>K089</td> <td>K178</td> </tr> <tr> <td>Nbr of poles:</td> <td>4</td> <td>6</td> <td>8</td> <td>12</td> <td>18</td> </tr> </table>	Size:	K032	K044	K064	K089	K178	Nbr of poles:	4	6	8	12	18
Size:	K032	K044	K064	K089	K178								
Nbr of poles:	4	6	8	12	18								
Degree of protection	IP00												
Cooling	Natural cooling												
Altitude	Up to 1000m (IEC 60034-1) (for higher altitude see §3.1.1 for derating)												
Rated Supply voltage of drive	115 VAC for size 32, 44, 64 and 89 240 VAC for size 178												
Rated Supply voltage of motor	100 VACrms phase to phase for size 32, 44, 64 and 89 214 VACrms phase to phase for size 178												
Connections	Power cables												
Insulation of the stator winding	Class F according to EN 60034-1												
Operating temperature	-15°C to +40°C for natural cooling version (IEC 60034-1)												
Storage temperature	-20... +60°C												

2.6. Product Code

Code	K	0	4	4	1	0	0	-	E	Y	1	-	C	E	
Product Series	K 0 4 4			1 0 0				-		E	Y	1	-		
Motor size	032, 044, 064, 089 and 178mm in relation with the motor diameter														
Motor length	Stack length 0.50 in, 1.00 in and 2.00 in														
Windings variant	See the following tables for selection														
Connection	Wye connection														
Commutation	1: Without Hall effect sensor 2: With Hall effect sensor (not available for size K178)														
Certification	-CE: CE certified														

3. TECHNICAL DATA

3.1. Kit selection

3.1.1. Altitude derating

From 0 to 1000 m : no derating

1000 to 4000 m: torque derating of 10% for each step of 1000 m for air cooled

3.1.2. Temperature derating

The maximal temperature for natural cooling is 40°C. But, it is possible to increase a little bit the ambient temperature above 40°C, with a torque reduction. The following formula gives an indicative about the torque derating at low speed. But in any case refer to PARKER technical department to know the exact values.

At low speed the torque derating is given by the following formula for an ambient temperature > 40°C.

$$\text{Torque_derating}[\%] = 100 * \sqrt{\frac{(145^{\circ}\text{C} - \text{Ambient_temperature}^{\circ}\text{C})}{105^{\circ}\text{C}}}$$



At high speed, the calculation is more complex, and the derating is much more important.
Please refer to PARKER to know the precise data of torque derating according to ambient temperature at high speed for a specific kit.

3.1.3. Thermal equivalent torque (rms torque)

The selection of the right kit can be made through the calculation of the rms torque M_{rms} (i.e. root mean squared torque) (sometimes called equivalent torque).

This calculation does not take into account the thermal time constant. It can be used only if the overload time is much shorter than the copper thermal time constant.

The rms torque M_{rms} reflects the heating of the kit during its duty cycle.

Let us consider:

- the period of the cycle T [s],
- the successively samples of movements i characterized each ones by the maximal torque M_i [Nm] reached during the duration Δt_i [s].

So, the rms torque M_{rms} can be calculated through the following basic formula:

$$M_{rms} = \sqrt{\frac{1}{T} * \sum_{i=1}^n M_i^2 \Delta t_i}$$

Example:

For a cycle of 2s at 0 Nm and 2s at 10Nm and a period of 4 s, the rms torque is

$$M_{rms} = \sqrt{\frac{1}{4} * 10^2 * 2} = 7,07 Nm$$

Illustration :

Acceleration-deceleration torque:	10 Nm for 0,1 s.
Resistant torque:	1 Nm during all the movement.
Max-min speed:	± 2800 rpm during 0,2 s.
Max torque provided by the motor:	11 Nm.
rms torque:	6 Nm.

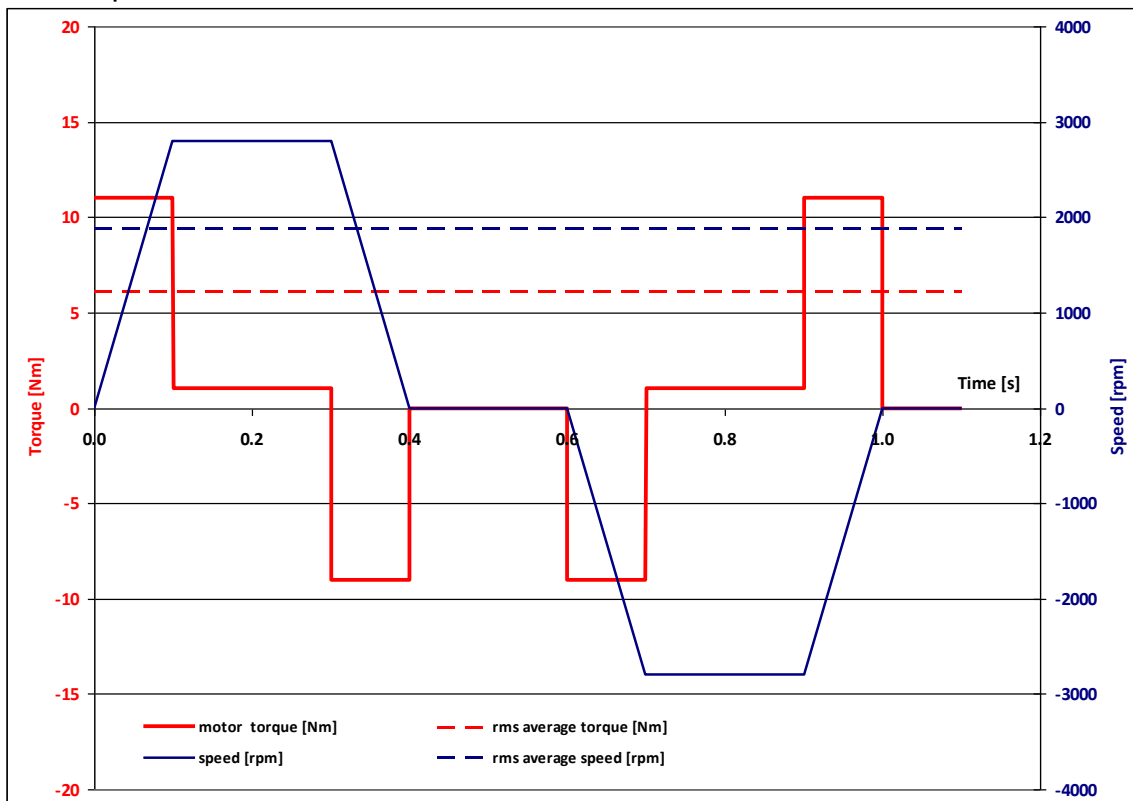

The maximal torque M_i delivered by the kit at each segment i of movement is obtained by the algebraic sum of the acceleration-deceleration torque and the resistant torque. Therefore, M_{max} corresponds to the maximal value of M_i .



The motor adapted to the duty cycle has to provide the rms torque M_{rms} at the rms speed(*) without extra heating. This means that the permanent torque M_n available at the average speed presents a sufficient margin regarding the rms torque M_{rms} .

$$\Omega_{rms} = \sqrt{\frac{1}{T} * \sum_{i=1}^n \Omega_i^2 \Delta t_i}$$

(*) rms speed is calculated thanks to the same formula as that used for the rms torque. The mean speed cannot be used (in general mean speed is equal to zero). Only use the rms speed.

Furthermore, each M_i and speed associated Ω_i of the duty cycle has to be located in the operational area of the torque vs speed curve.

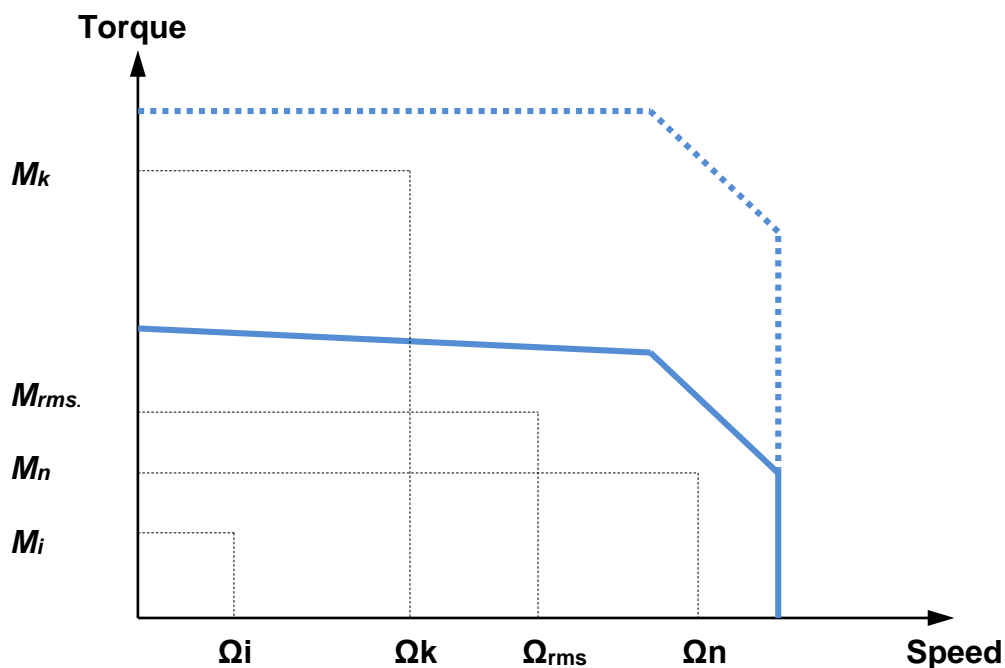

3.1.4. Kit Selection

The selection of a particular frame size and winding for an application depends on:

- **Dimensions (diameter and length) requirement**
- **Power (torque and speed) requirement**
- **Voltage and current available or required**

The first two items are dependent on the load and performance specifications of the application. They result in the selection of a particular frame size (032 through 178) and stack length. The winding to be used will then be determined by the voltage and current available or required.



Voltage and maximum speed: The bus voltage and maximum speed will approximately determine the required voltage constant (K_e).
Note that in many windings, the max mechanical speed limits the top speed.

Example:

Kit	: K178050-EY
Power supply	: 240Vac
Bus voltage	: $U_{bus}=324$ Vdc
Voltage drop from drive	: 7%
Motor voltage Lead to Lead	: $(U_{bus}/\sqrt{2})*(1-0.07)=213$ Vrms
Voltage constant	: $K_e=75.85$ Vrms/krpm
Theoretical Maximum speed	: $N_{max} = (213/75.85)*1000 = \sim 2800$ rpm

Current and torque: The maximum load and acceleration will determine the current required, determined by the torque constant $K_{t(sine)}$

Example:

Assume a requirement of 0.36 Nm.
If a Kit with a particular winding having $K_t=0.176$ Nm/Arms is chosen,
it will now require a current of $0.36/0.176=2$ Arms.

Note: K_E and K_t are directly proportional to each other. Increasing K_E will also increase K_t ; decreasing K_E will also decrease K_t . The result is that as the voltage requirement changes, the current requirement changes inversely.

Current and voltage from torque and speed:

The required speed and torque will determine the required voltage on the motor leads due to the polarity, K_t , K_e , Inductance and resistance.

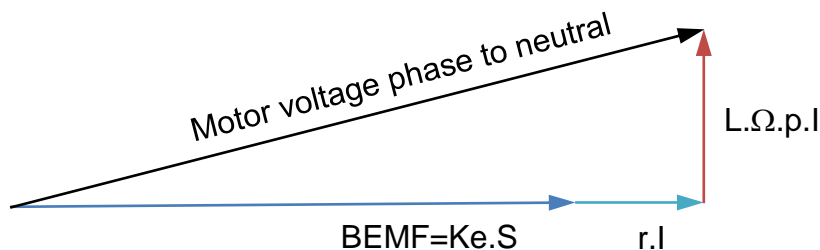

Example:

Kit	: K178050-EY
Required speed S	: 2476 rpm
Required speed S in rad/s Ω	$= 2476 \times 2\pi/60 = 259$ rad/s
Required torque T	: 5.35 N.m
Motor K_e phase to phase	: 75.85 V/Krpm phase to phase
Motor K_e phase to neutral	$= 75.85/\sqrt{3} = 43.792$ V/Krpm phase to neutral
Motor torque constant K_t	: 1.2548 N.m/amp
Motor resistance r phase to phase	: 2.5252 ohms
Motor resistance r phase to neutral	$= 2.5252/2 = 1.26$ ohms
Motor inductance L phase to phase	: 9.5593 mH
Motor inductance L phase to neutral	$= 9.5593 /2 = 4.78$ mH
Number of pair of poles p	: 9



Motor will require a current I of $T/Kt = 5.35 / 1.2548 = 4.267$ Arms.

Total Voltage Requirement on the motor leads between phase to neutral is:

$$\text{Uphase to neutral} = \sqrt{(K_{e_{ph-n}} \cdot S + r_{ph-n} \cdot I)^2 + (L_{ph-n} \cdot \omega \cdot p \cdot I)^2}$$

$$\text{Uphase to neutral} = \sqrt{\left(43.792 \times \frac{2476}{1000} + 1.26 \times 4.267\right)^2 + (4.78 \cdot 10^{-3} \times 259 \times 9 \times 4.267)^2}$$

$$\text{Uphase to neutral} = 123.4 \text{ V}$$

$$\text{Uphase to phase} = 123.4 \times \sqrt{3}$$

$$\text{Uphase to phase} = 213.7 \text{ V}$$



Parker has a range of 3 windings that are available for each stack length within a particular frame size to meet the majority of your application requirements. Parker does have additional windings that are available upon request from Parker's Application Engineering Department.

Use the performance specifications on the following pages to help determine the best solution for your specific application requirements.

3.1.5. Current limitation at stall conditions (i.e. speed < 3 rpm)

Recommended reduced current at speed < 3 rpm:

$$I_{reduced} = \frac{1}{\sqrt{2}} * I_0 \cong 0.7 * I_0$$

	<p>Warning: The current must be limited to the prescribed values. If the nominal torque has to be maintained at stop or low speed (< 3 rpm), imperatively limit the current to 70% of I_0 (permanent current at low speed), in order to avoid an excessive overheating of the motor.</p>
	<p>Please refer to the drive technical documentation for any further information and to choose functions to program the drive.</p>

3.1.6. Peak current limitations

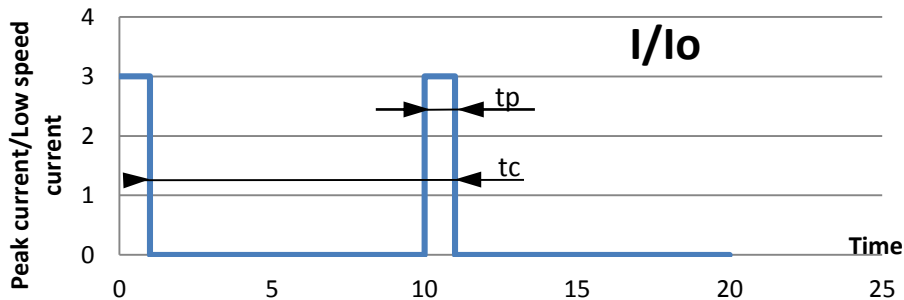

It is possible to use the K Series Kit with a current higher than the permanent current. But, to avoid any overheating, the following rules must be respected.

- 1) The peak currents and peak torques given in the data sheet must never be exceeded
- 2) The thermal equivalent torque must be respected (§3.1.3)
- 3) If 1) and 2) are respected (it can limit the peak current value or duration), the peak current duration (t_p) must be limited, in addition, accordingly to the following table (I_0 is the permanent current at low speed):

I_{peak}/I_n	$I_p/I_0 = 2$	$I_p/I_0 = 3$	$I_p/I_0 = 4$	$I_p/I_0 > 5$
K032	tp<0.8 s	tp<0.3s	tp<0.15s	tp<0.1s
K044				
K064	tp<1.5s	tp<0.6s	tp<0.3s	tp<0.2s
K089				
K178	tp<3s	tp<1.5s	not allowed	

The peak current duration is calculated for a temperature rise of 3°C
Consult us for more demanding applications.

3.2. K Characteristics: Torque, speed, current, power...

3.2.1. Voltage withstand characteristics

	The K series is designed to be supplied by a drive with a maximum DC bus voltage of : 155VDC for size 32, 44, 64 and 89 340 VDC for size 178..
--	--

3.2.2. Torque, Speed, Current characteristics

The torque vs speed graph below explains different intrinsic values given in the next tables.

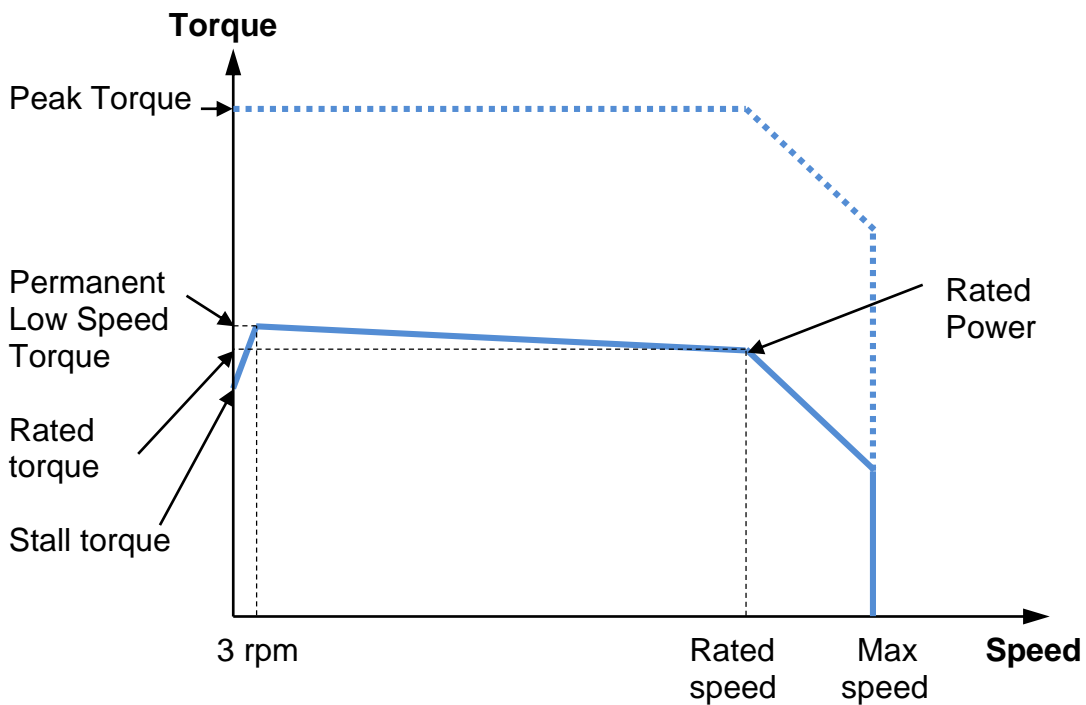



3.2.3. K datas – DC bus voltage 12VDC

Motor	Rated Power Pn (kW)	Rated Torque Mn (Nm)	Rated Speed Nn [rpm]	Rated Current In [Arms]	Low Speed Torque Mo [Nm]	Low speed Current Io [Arms]	Peak Torque Mpeak [Nm]	Peak Current I peak [Arms]	Max. Speed Nmax [rpm]
K032050-7Y_	0,017	0,07	2161	3,2	0,07	3,2	0,26	11,2	4797
K032050-8Y_	0,009	0,07	1123	2,5	0,07	2,5	0,26	8,8	3707
K032100-7Y_	0,012	0,13	888	2,7	0,13	2,7	0,44	9,6	2418
K032100-8Y_	0,005	0,13	363	2,1	0,13	2,2	0,45	7,6	1869
K032200-7Y_	0,006	0,21	270	2,2	0,21	2,2	0,72	7,8	1204
K044050-7Y_	0,018	0,19	938	4,1	0,19	4,2	0,66	14,6	2437
K044050-8Y_	0,009	0,19	456	3,3	0,19	3,3	0,66	11,6	1949
K044100-7Y_	0,012	0,33	356	3,6	0,33	3,6	1,16	12,6	1208
K044100-8Y_	0,004	0,33	114	2,9	0,33	2,9	1,15	10,1	966
K044200-7Y_	0,005	0,54	85	2,9	0,54	2,9	1,88	10,3	607
K064050-8Y_	0,005	0,53	89	4,0	0,53	4,0	1,86	14,0	832
K089050-6Y_	0,020	1,34	139	7,6	1,34	7,6	4,72	26,6	624
K089050-7Y_	0,003	1,33	19	6,1	1,33	6,1	4,66	21,3	507
K089100-6Y_	0,010	2,37	39	6,7	2,37	6,7	8,32	23,4	312
K089200-4Y_	0,035	3,89	86	8,9	3,90	8,9	13,7	31,3	253
K178050-6Y_	0,043	7,02	59	14,0	7,03	14,0	26,8	53,3	221



3.2.4. K datas – DC bus voltage **24VDC**

Motor	Rated Power Pn (kW)	Rated Torque Mn (Nm)	Rated Speed Nn [rpm]	Rated Current In [Arms]	Low Speed Torque Mo [Nm]	Low speed Current Io [Arms]	Peak Torque Mpeak [Nm]	Peak Current I peak [Arms]	Max. Speed Nmax [rpm]
K032050-7Y_	0,059	0,07	7795	3,1	0,07	3,2	0,26	11,2	10000
K032050-8Y_	0,042	0,07	5473	2,5	0,07	2,5	0,26	8,8	8155
K032050-EY_	0,020	0,07	2515	1,6	0,07	1,6	0,26	5,5	5126
K032100-7Y_	0,049	0,12	3744	2,7	0,13	2,7	0,44	9,6	5320
K032100-8Y_	0,034	0,13	2572	2,1	0,13	2,2	0,45	7,6	4111
K032100-EY_	0,014	0,13	1071	1,3	0,13	1,4	0,45	4,7	2584
K032200-7Y_	0,036	0,20	1704	2,2	0,21	2,2	0,72	7,8	2649
K032200-8Y_	0,024	0,21	1118	1,7	0,21	1,7	0,73	6,1	2047
K032200-EY_	0,008	0,21	365	1,1	0,21	1,1	0,73	3,9	1287
K044050-7Y_	0,073	0,19	3763	4,1	0,19	4,2	0,66	14,6	5361
K044050-8Y_	0,053	0,19	2723	3,3	0,19	3,3	0,66	11,6	4288
K044050-EY_	0,023	0,19	1173	2,1	0,19	2,1	0,66	7,3	2680
K044100-7Y_	0,061	0,33	1771	3,6	0,33	3,6	1,16	12,6	2657
K044100-8Y_	0,043	0,33	1250	2,8	0,33	2,9	1,15	10,1	2126
K044100-EY_	0,016	0,33	474	1,8	0,33	1,8	1,16	6,3	1329
K044200-7Y_	0,045	0,53	804	2,9	0,54	2,9	1,88	10,3	1334
K044200-8Y_	0,030	0,53	539	2,3	0,53	2,3	1,87	8,2	1068
K044200-EY_	0,008	0,54	145	1,5	0,54	1,5	1,88	5,1	667
K064050-8Y_	0,058	0,53	1053	4,0	0,53	4,0	1,86	14,0	1830
K064050-9Y_	0,039	0,53	700	3,2	0,53	3,2	1,85	11,1	1464
K064050-EY_	0,022	0,53	396	2,5	0,53	2,5	1,87	8,8	1144
K064100-8Y_	0,047	0,9	484	3,5	0,9	3,5	3,29	12,3	915
K064100-9Y_	0,030	0,9	305	2,8	0,9	2,8	3,28	9,8	732
K064100-EY_	0,015	0,9	152	2,2	0,9	2,2	3,30	7,7	572
K064200-8Y_	0,033	1,6	204	2,9	1,6	2,9	5,50	10,3	457
K064200-9Y_	0,018	1,6	113	2,3	1,6	2,3	5,47	8,2	366
K064200-EY_	0,006	1,6	36	1,8	1,6	1,8	5,51	6,5	286
K089050-6Y_	0,117	1,3	839	7,5	1,3	7,6	4,72	26,6	1373
K089050-7Y_	0,082	1,3	597	6,0	1,3	6,1	4,66	21,3	1115
K089050-9Y_	0,030	1,3	216	3,8	1,3	3,9	4,62	13,5	714
K089100-6Y_	0,098	2,4	396	6,6	2,4	6,7	8,32	23,4	686
K089100-7Y_	0,066	2,3	272	5,3	2,3	5,4	8,22	18,8	558
K089100-9Y_	0,019	2,3	77	3,4	2,3	3,4	8,15	11,9	357
K089200-4Y_	0,153	3,9	379	8,8	3,9	8,9	13,7	31,3	558
K089200-7Y_	0,045	3,9	111	4,4	3,9	4,5	13,7	15,6	279
K089200-9Y_	0,004	3,9	11	2,8	3,9	2,8	13,6	9,9	178
K178050-6Y_	0,217	7,0	297	13,9	7,0	14,0	26,8	53,3	486
K178050-8Y_	0,100	7,0	137	8,8	7,0	8,8	26,7	33,6	307
K178050-EY_	0,024	7,0	33	5,6	7,0	5,6	26,6	21,2	194
K178100-8Y_	0,077	13,6	54	8,6	13,7	8,6	48,0	30,2	153
K178100-9Y_	0,035	13,7	24	6,8	13,7	6,8	48,0	23,9	121
K178200-8Y_	0,047	23,2	19	7,3	23,2	7,3	81,5	25,7	77



3.2.5. K datas – DC bus voltage 48VDC

Motor	Rated Power Pn (kW)	Rated Torque Mn (Nm)	Rated Speed Nn [rpm]	Rated Current In [Arms]	Low Speed Torque Mo [Nm]	Low speed Current Io [Arms]	Peak Torque Mpeak [Nm]	Peak Current I peak [Arms]	Max. Speed Nmax [rpm]
K032050-7Y_	0,074	0,07	10000	3,1	0,07	3,2	0,26	11,2	10000
K032050-8Y_	0,075	0,07	10000	2,4	0,07	2,5	0,26	8,8	10000
K032050-EY_	0,061	0,07	7984	1,5	0,07	1,6	0,26	5,5	10000
K032100-7Y_	0,117	0,12	9499	2,6	0,13	2,7	0,44	9,6	10000
K032100-8Y_	0,090	0,12	6995	2,1	0,13	2,2	0,45	7,6	8596
K032100-EY_	0,051	0,13	3843	1,3	0,13	1,4	0,45	4,7	5403
K032200-7Y_	0,095	0,20	4576	2,1	0,21	2,2	0,72	7,8	5539
K032200-8Y_	0,071	0,20	3332	1,7	0,21	1,7	0,73	6,1	4280
K032200-EY_	0,038	0,21	1756	1,1	0,21	1,1	0,73	3,9	2691
K044050-7Y_	0,140	0,18	7500	3,9	0,19	4,2	0,66	14,6	7500
K044050-8Y_	0,136	0,18	7266	3,1	0,19	3,3	0,66	11,6	7500
K044050-EY_	0,077	0,18	3997	2,0	0,19	2,1	0,66	7,3	5604
K044100-7Y_	0,152	0,32	4603	3,4	0,33	3,6	1,16	12,6	5556
K044100-8Y_	0,117	0,32	3512	2,8	0,33	2,9	1,15	10,1	4445
K044100-EY_	0,064	0,33	1888	1,8	0,33	1,8	1,16	6,3	2778
K044200-7Y_	0,122	0,52	2237	2,9	0,54	2,9	1,88	10,3	2790
K044200-8Y_	0,092	0,52	1685	2,3	0,53	2,3	1,87	8,2	2232
K044200-EY_	0,048	0,53	863	1,5	0,54	1,5	1,88	5,1	1395
K064050-8Y_	0,160	0,52	2958	3,9	0,53	4,0	1,86	14,0	3826
K064050-9Y_	0,121	0,52	2225	3,1	0,53	3,2	1,85	11,1	3061
K064050-EY_	0,088	0,53	1590	2,5	0,53	2,5	1,87	8,8	2391
K064100-8Y_	0,140	0,9	1447	3,5	0,9	3,5	3,29	12,3	1913
K064100-9Y_	0,104	0,9	1077	2,8	0,9	2,8	3,28	9,8	1530
K064100-EY_	0,074	0,9	757	2,2	0,9	2,2	3,30	7,7	1196
K064200-8Y_	0,112	1,5	692	2,9	1,6	2,9	5,50	10,3	956
K064200-9Y_	0,081	1,5	504	2,3	1,6	2,3	5,47	8,2	765
K064200-EY_	0,056	1,6	342	1,8	1,6	1,8	5,51	6,5	598
K089050-6Y_	0,303	1,3	2223	7,3	1,3	7,6	4,72	26,6	2870
K089050-7Y_	0,234	1,3	1723	5,9	1,3	6,1	4,66	21,3	2332
K089050-9Y_	0,129	1,3	944	3,8	1,3	3,9	4,62	13,5	1493
K089100-6Y_	0,266	2,3	1099	6,5	2,4	6,7	8,32	23,4	1435
K089100-7Y_	0,204	2,3	845	5,3	2,3	5,4	8,22	18,8	1166
K089100-9Y_	0,108	2,3	448	3,4	2,3	3,4	8,15	11,9	746
K089200-4Y_	0,378	3,7	964	8,6	3,9	8,9	13,7	31,3	1166
K089200-7Y_	0,162	3,8	404	4,4	3,9	4,5	13,7	15,6	583
K089200-9Y_	0,081	3,8	201	2,8	3,9	2,8	13,6	9,9	373
K178050-6Y_	0,546	6,8	766	13,6	7,0	14,0	26,8	53,3	1015
K178050-8Y_	0,315	6,9	434	8,7	7,0	8,8	26,7	33,6	641
K178050-EY_	0,164	6,9	226	5,5	7,0	5,6	26,6	21,2	406
K178100-8Y_	0,290	13,5	204	8,5	13,7	8,6	48,0	30,2	321
K178100-9Y_	0,206	13,6	145	6,8	13,7	6,8	48,0	23,9	254
K178100-EY_	0,141	13,6	99	5,4	13,6	5,4	47,8	19,1	203
K178200-8Y_	0,235	23,0	97	7,2	23,2	7,3	81,5	25,7	160
K178200-9Y_	0,161	23,1	66	5,8	23,2	5,8	81,6	20,3	127
K178200-EY_	0,103	23,1	43	4,6	23,1	4,6	81,3	16,2	102



3.2.6. K datas – DC bus voltage 96VDC

Motor	Rated Power Pn (kW)	Rated Torque Mn (Nm)	Rated Speed Nn [rpm]	Rated Current In [Arms]	Low Speed Torque Mo [Nm]	Low speed Current Io [Arms]	Peak Torque Mpeak [Nm]	Peak Current I peak [Arms]	Max. Speed Nmax [rpm]
K032050-7Y_	0,074	0,07	10000	3,1	0,07	3,2	0,26	11,2	10000
K032050-8Y_	0,075	0,07	10000	2,4	0,07	2,5	0,26	8,8	10000
K032050-EY_	0,075	0,07	10000	1,5	0,07	1,6	0,26	5,5	10000
K032100-7Y_	0,122	0,12	10000	2,5	0,13	2,7	0,44	9,6	10000
K032100-8Y_	0,124	0,12	10000	2,0	0,13	2,2	0,45	7,6	10000
K032100-EY_	0,118	0,12	9429	1,3	0,13	1,4	0,45	4,7	10000
K032200-7Y_	0,183	0,17	10000	1,9	0,21	2,2	0,72	7,8	10000
K032200-8Y_	0,154	0,19	7802	1,6	0,21	1,7	0,73	6,1	8747
K032200-EY_	0,095	0,20	4544	1,1	0,21	1,1	0,73	3,9	5498
K044050-7Y_	0,140	0,18	7500	3,9	0,19	4,2	0,66	14,6	7500
K044050-8Y_	0,139	0,18	7500	3,1	0,19	3,3	0,66	11,6	7500
K044050-EY_	0,140	0,18	7500	2,0	0,19	2,1	0,66	7,3	7500
K044100-7Y_	0,233	0,30	7500	3,2	0,33	3,6	1,16	12,6	7500
K044100-8Y_	0,232	0,30	7500	2,6	0,33	2,9	1,15	10,1	7500
K044100-EY_	0,156	0,31	4721	1,7	0,33	1,8	1,16	6,3	5677
K044200-7Y_	0,257	0,48	5136	2,6	0,54	2,9	1,88	10,3	5701
K044200-8Y_	0,208	0,50	3993	2,2	0,53	2,3	1,87	8,2	4561
K044200-EY_	0,125	0,52	2297	1,4	0,54	1,5	1,88	5,1	2851
K064050-8Y_	0,263	0,50	5000	3,8	0,53	4,0	1,86	14,0	5000
K064050-9Y_	0,262	0,50	5000	3,0	0,53	3,2	1,85	11,1	5000
K064050-EY_	0,213	0,51	3975	2,4	0,53	2,5	1,87	8,8	4886
K064100-8Y_	0,313	0,9	3381	3,3	0,9	3,5	3,29	12,3	3909
K064100-9Y_	0,246	0,9	2620	2,7	0,9	2,8	3,28	9,8	3127
K064100-EY_	0,188	0,9	1959	2,1	0,9	2,2	3,30	7,7	2443
K064200-8Y_	0,262	1,5	1668	2,8	1,6	2,9	5,50	10,3	1954
K064200-9Y_	0,204	1,5	1284	2,3	1,6	2,3	5,47	8,2	1564
K064200-EY_	0,153	1,5	951	1,8	1,6	1,8	5,51	6,5	1222
K089050-6Y_	0,626	1,2	5000	6,7	1,3	7,6	4,72	26,6	5000
K089050-7Y_	0,514	1,2	4003	5,6	1,3	6,1	4,66	21,3	4766
K089050-9Y_	0,318	1,3	2389	3,7	1,3	3,9	4,62	13,5	3050
K089100-6Y_	0,579	2,2	2520	6,2	2,4	6,7	8,32	23,4	2933
K089100-7Y_	0,464	2,2	1995	5,1	2,3	5,4	8,22	18,8	2383
K089100-9Y_	0,280	2,3	1182	3,3	2,3	3,4	8,15	11,9	1525
K089200-4Y_	0,773	3,4	2150	7,9	3,9	8,9	13,7	31,3	2383
K089200-7Y_	0,387	3,7	989	4,3	3,9	4,5	13,7	15,6	1191
K089200-9Y_	0,228	3,8	575	2,8	3,9	2,8	13,6	9,9	763
K178050-6Y_	1,126	6,2	1738	12,3	7,0	14,0	26,8	53,3	2075
K178050-8Y_	0,720	6,7	1031	8,4	7,0	8,8	26,7	33,6	1311
K178050-EY_	0,431	6,8	601	5,4	7,0	5,6	26,6	21,2	830
K178100-8Y_	0,697	13,3	502	8,3	13,7	8,6	48,0	30,2	655
K178100-9Y_	0,534	13,4	380	6,7	13,7	6,8	48,0	23,9	519
K178100-EY_	0,405	13,4	288	5,4	13,6	5,4	47,8	19,1	415
K178200-8Y_	0,595	22,7	251	7,1	23,2	7,3	81,5	25,7	328
K178200-9Y_	0,450	22,9	188	5,7	23,2	5,8	81,6	20,3	259
K178200-EY_	0,336	22,9	140	4,6	23,145	4,6	81,3	16,2	208



3.2.7. K datas – Power voltage 240VAC

Motor	Rated Power Pn (kW)	Rated Torque Mn (Nm)	Rated Speed Nn [rpm]	Rated Current In [Arms]	Low Speed Torque Mo [Nm]	Low speed Current Io [Arms]	Peak Torque Mpeak [Nm]	Peak Current I peak [Arms]	Max. Speed Nmax [rpm]
K178050-6Y_	1,43	4,6	3000	9,1	7,0	14,0	26,8	53,3	3000
K178050-8Y_	1,43	4,6	3000	5,7	7,0	8,8	26,7	33,6	3000
K178050-EY_	1,39	5,4	2477	4,3	7,0	5,6	26,6	21,2	2818
K178100-8Y_	2,05	9,8	2006	6,1	13,7	8,6	48,0	30,2	2225
K178100-9Y_	1,82	11,3	1531	5,7	13,7	6,8	48,0	23,9	1761
K178100-EY_	1,51	12,1	1192	4,8	13,6	5,4	47,8	19,1	1409
K178200-8Y_	2,00	19,2	994	6,1	23,2	7,3	81,5	25,7	1112
K178200-9Y_	1,66	20,6	768	5,1	23,2	5,8	81,6	20,3	881
K178200-EY_	1,34	21,3	601	4,3	23,1	4,6	81,3	16,2	705



3.2.8. Further Data

Motor	Max. Mechanical Speed [rpm]	Kt (sine) [Nm/Arms]	Ke [Vrms/krpm]	Inductance [mH]	Winding Resistance [ohms]	Moment of Inertia J [kgmm ²]	Polarity p [-]	Motor Weight [kg]	Thermal Resistance R _{thw-a} [°C/W]	Motor Thermal Time Constant t _{th} [min]
K032050-7Y_	10 000	0,023	1,396	0,66	1,3192	0,32	4	0,07	3,44	9,74
K032050-8Y_	10 000	0,030	1,807	1,11	2,1526	0,32	4	0,07	3,44	9,74
K032050-EY_	10 000	0,048	2,874	2,81	5,4447	0,32	4	0,07	3,44	9,74
K032100-7Y_	10 000	0,046	2,769	1,32	1,7748	0,63	4	0,12	3,44	1,50
K032100-8Y_	10 000	0,059	3,584	2,22	2,8960	0,63	4	0,12	3,44	1,50
K032100-EY_	10 000	0,094	5,702	5,61	7,3251	0,63	4	0,12	3,44	1,50
K032200-7Y_	10 000	0,092	5,562	2,65	2,6859	1,3	4	0,26	3,44	9,74
K032200-8Y_	10 000	0,119	7,198	4,43	4,3828	1,3	4	0,26	3,44	9,74
K032200-EY_	10 000	0,189	11,451	11,22	11,0856	1,3	4	0,26	3,44	9,74
K044050-7Y_	7 500	0,045	2,749	0,80	1,1336	1,41	6	0,10	2,36	11
K044050-8Y_	7 500	0,057	3,436	1,25	1,7867	1,41	6	0,10	2,36	11
K044050-EY_	7 500	0,091	5,497	3,21	4,5449	1,41	6	0,10	2,36	11
K044100-7Y_	7 500	0,092	5,545	1,60	1,5112	2,9	6	0,22	2,36	11
K044100-8Y_	7 500	0,115	6,931	2,50	2,3818	2,9	6	0,22	2,36	11
K044100-EY_	7 500	0,183	11,090	6,41	6,0588	2,9	6	0,22	2,36	11
K044200-7Y_	7 500	0,183	11,042	3,20	2,2659	5,8	6	0,40	2,36	11
K044200-8Y_	7 500	0,228	13,803	5,00	3,5714	5,8	6	0,40	2,36	11
K044200-EY_	7 500	0,365	22,085	12,81	9,0850	5,8	6	0,40	2,36	11
K064050-8Y_	5 000	0,133	8,053	2,00	1,7353	9	8	0,29	1,68	22
K064050-9Y_	5 000	0,167	10,066	3,13	2,7351	9	8	0,29	1,68	22
K064050-EY_	5 000	0,213	12,885	5,12	4,4143	9	8	0,29	1,68	22
K064100-8Y_	5 000	0,266	16,106	4,00	2,2176	18	8	0,57	1,68	22
K064100-9Y_	5 000	0,333	20,132	6,25	3,4953	18	8	0,57	1,68	22
K064100-EY_	5 000	0,426	25,769	10,24	5,6412	18	8	0,57	1,68	22
K064200-8Y_	5 000	0,533	32,212	7,98	3,1791	36	8	1,13	1,68	22
K064200-9Y_	5 000	0,666	40,265	12,48	5,0106	36	8	1,13	1,68	22
K064200-EY_	5 000	0,853	51,539	20,44	8,0869	36	8	1,13	1,68	22
K089050-6Y_	5 000	0,178	10,734	1,21	0,7899	37	12	0,50	1,02	28
K089050-7Y_	5 000	0,219	13,211	1,83	1,2258	37	12	0,50	1,02	28
K089050-9Y_	5 000	0,341	20,641	4,47	3,0451	37	12	0,50	1,02	28
K089100-6Y_	5 000	0,355	21,467	2,42	1,0151	78	12	1,00	1,02	28
K089100-7Y_	5 000	0,437	26,421	3,66	1,5754	78	12	1,00	1,02	28
K089100-9Y_	5 000	0,683	41,283	8,94	3,9135	78	12	1,00	1,02	28
K089200-4Y_	5 000	0,437	26,421	1,83	0,5673	150	12	1,99	1,02	28
K089200-7Y_	5 000	0,874	52,842	7,32	2,2746	150	12	1,99	1,02	28
K089200-9Y_	5 000	1,366	82,566	17,88	5,6504	150	12	1,99	1,02	28
K178050-6Y_	3 000	0,502	30,341	1,53	0,3996	470	18	2,40	0,50	108
K178050-8Y_	3 000	0,795	48,040	3,83	1,0059	470	18	2,40	0,50	108
K178050-EY_	3 000	1,255	75,853	9,56	2,5252	470	18	2,40	0,50	108
K178100-8Y_	3 000	1,589	96,061	7,67	1,2460	920	18	3,71	0,50	108
K178100-9Y_	3 000	2,007	121,341	12,24	1,9845	920	18	3,71	0,50	108
K178100-EY_	3 000	2,509	151,676	19,12	3,1278	920	18	3,71	0,50	108
K178200-8Y_	3 000	3,178	192,123	15,34	1,7260	1 800	18	6,34	0,50	108
K178200-9Y_	3 000	4,015	242,681	24,47	2,7491	1 800	18	6,34	0,50	108
K178200-EY_	3 000	5,018	303,352	38,24	4,3329	1 800	18	6,34	0,50	108

3.2.9. Electromagnetic losses

	<p><u>Caution:</u> Following data result from our best estimations but are indicative. They can vary from one kit to another and with temperature. No responsibility will be accepted for direct or indirect losses or damages due to the use of these data.</p>
---	--

Tf: Rotor shaft Dynamic Friction
 Kd: Rotor shaft Viscous Damping
 Torque losses = Tf + Kd x speed/1000

Type	Tf [Nm]	Kd [Nm/1000rpm]
K032050	0.0003	0.0001
K032100	0.0007	0.0002
K032200	0.0013	0.0004
K044050	0.0010	0.0004
K044100	0.0019	0.0007
K044200	0.0039	0.0014
K064050	0.0030	0.0010
K064100	0.0060	0.0021
K064200	0.0120	0.0042
K089050	0.0097	0.0034
K089100	0.0193	0.0068
K089200	0.0387	0.0136
K178050	0.0485	0.0561
K178100	0.0970	0.1123
K178200	0.1940	0.2246

3.2.10. Electric time constant & Mechanical time constant

With following values given in the kit data sheet:

- L_{ph_ph}** inductance of the motor phase to phase [H],
- R_{ph_ph}** resistance of the motor phase to phase at 25°C [Ohm].
- J** inertia of the rotor [kgm²],
- K_b** Voltage constant [V/rad/s]
- Ke_{ph_ph}** back emf coefficient phase to phase [$V_{rms}/rad/s$]= $K_b/\sqrt{2}$

Electric time constant:

$$\tau_{elec} = \frac{L_{ph_ph}}{R_{ph_ph}}$$

Mechanical time constant:

$$\tau_{mech} = \frac{0.5 * R_{ph_ph} * J}{(Ke_{ph_ph})^2}$$

Hereunder is given an overall summary of kit time constants:

Type	Electric time constant [ms]	Mechanical time constant [ms]
K032050_EY	0.5	1.1
K032100_EY	0.8	0.8
K032200_EY	1	0.6
K044050_EY	0.7	1.2
K044100_EY	1.1	0.8
K044200_EY	1.4	0.6
K064050_EY	1.2	1.3
K064100_EY	1.8	0.8
K064200_EY	2.5	0.6
K089050_9Y	1.5	1.4
K089100_9Y	2.3	1
K089200_9Y	3.1	0.7
K178050_EY	3.8	1.1
K178100_EY	6.2	0.7
K178200_EY	8.9	0.5

3.3. Dimension drawings

3.3.1. K032 - Stator

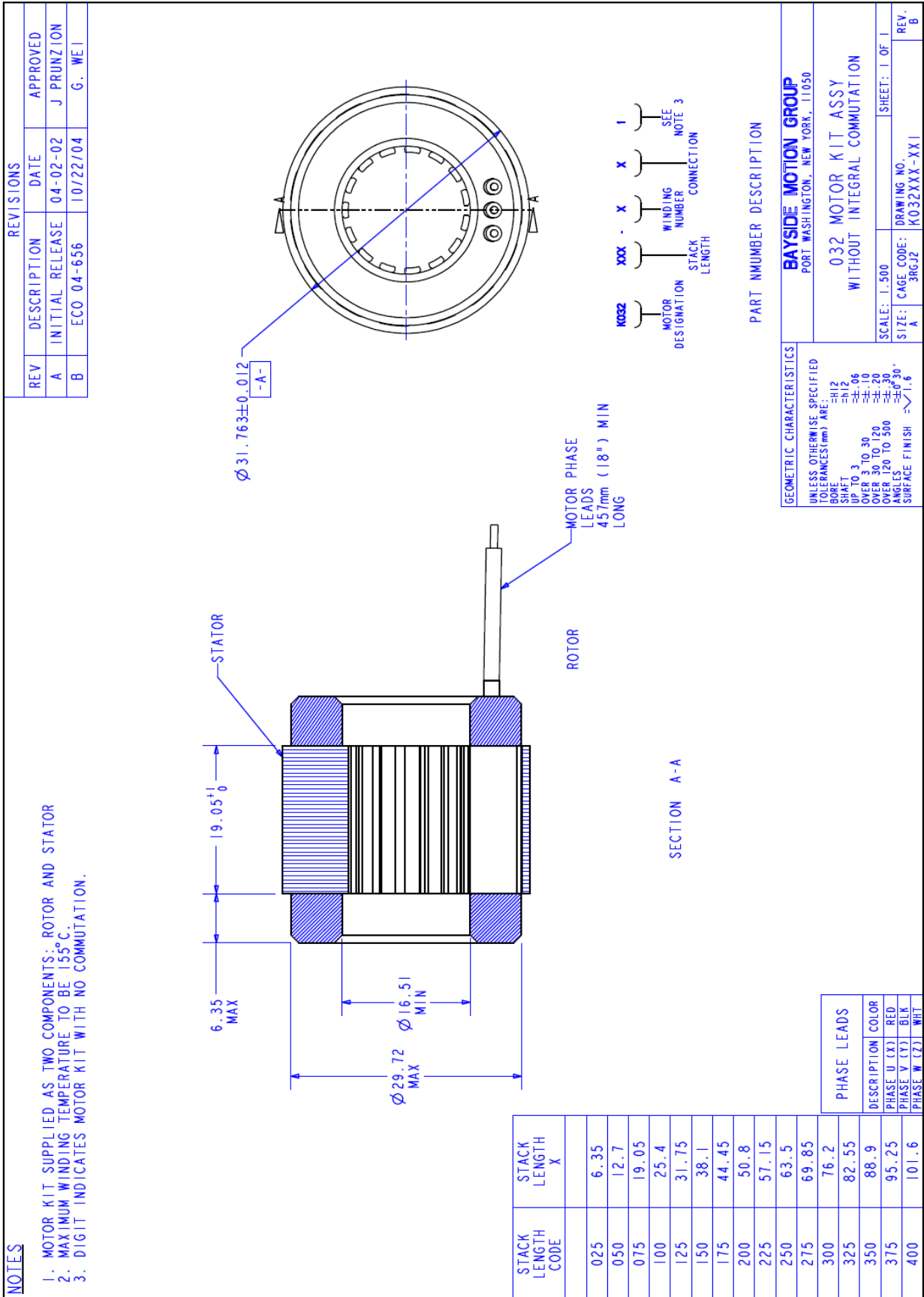

3.3.2. K032 - Rotor

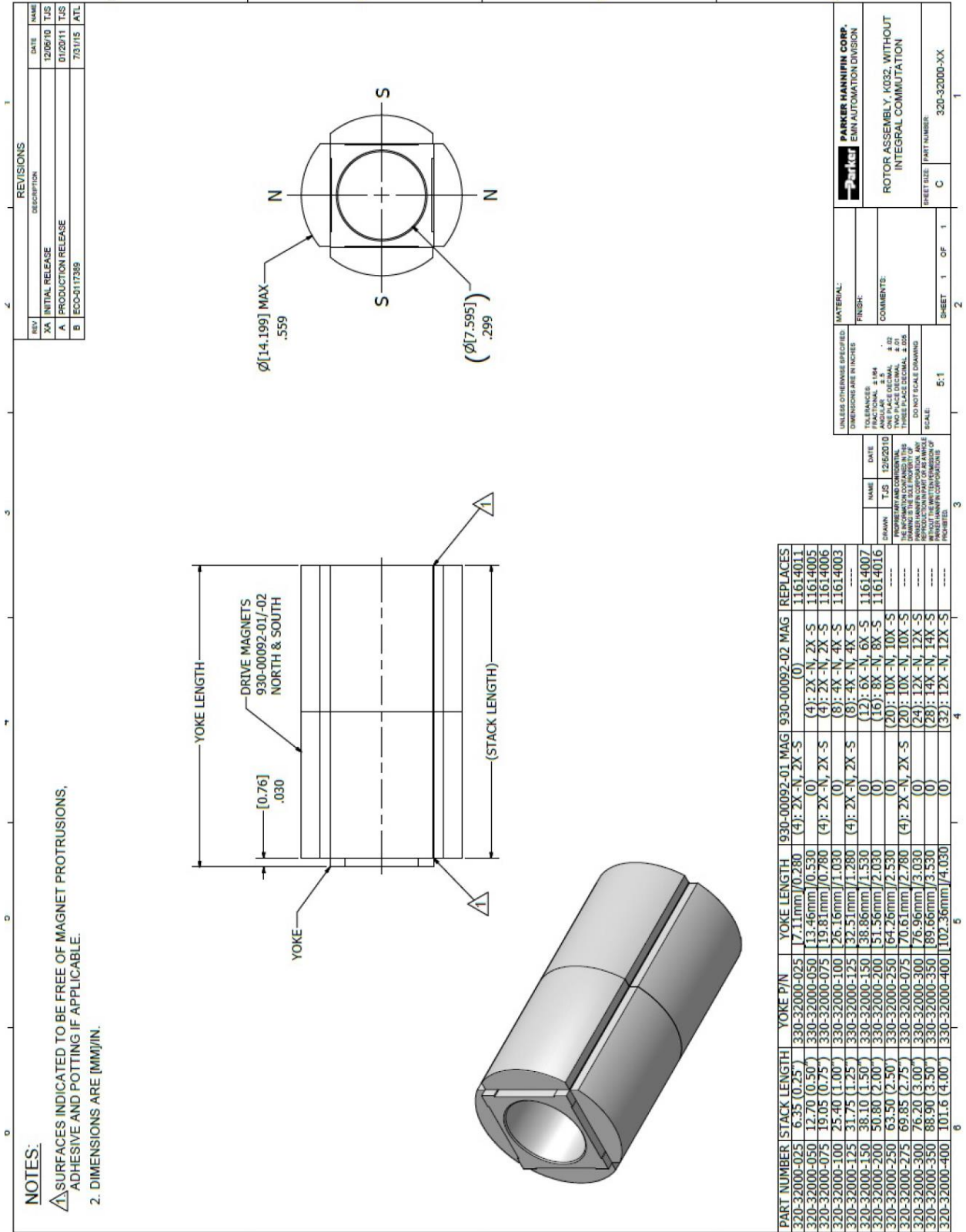

3.3.3. K032 – Stator with Hall effect sensor

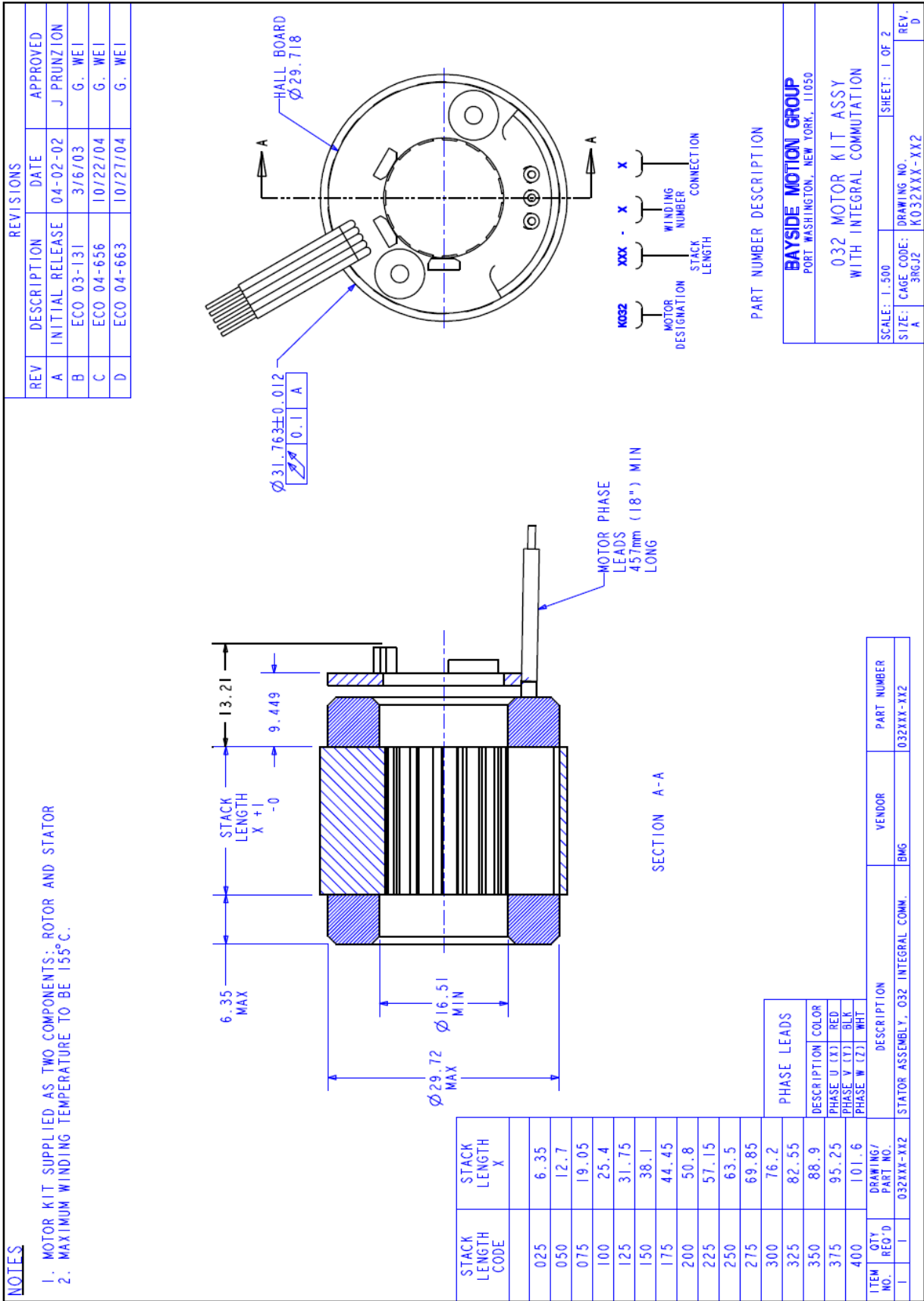

3.3.4. K032 – Rotor with magnets for Hall effect sensor

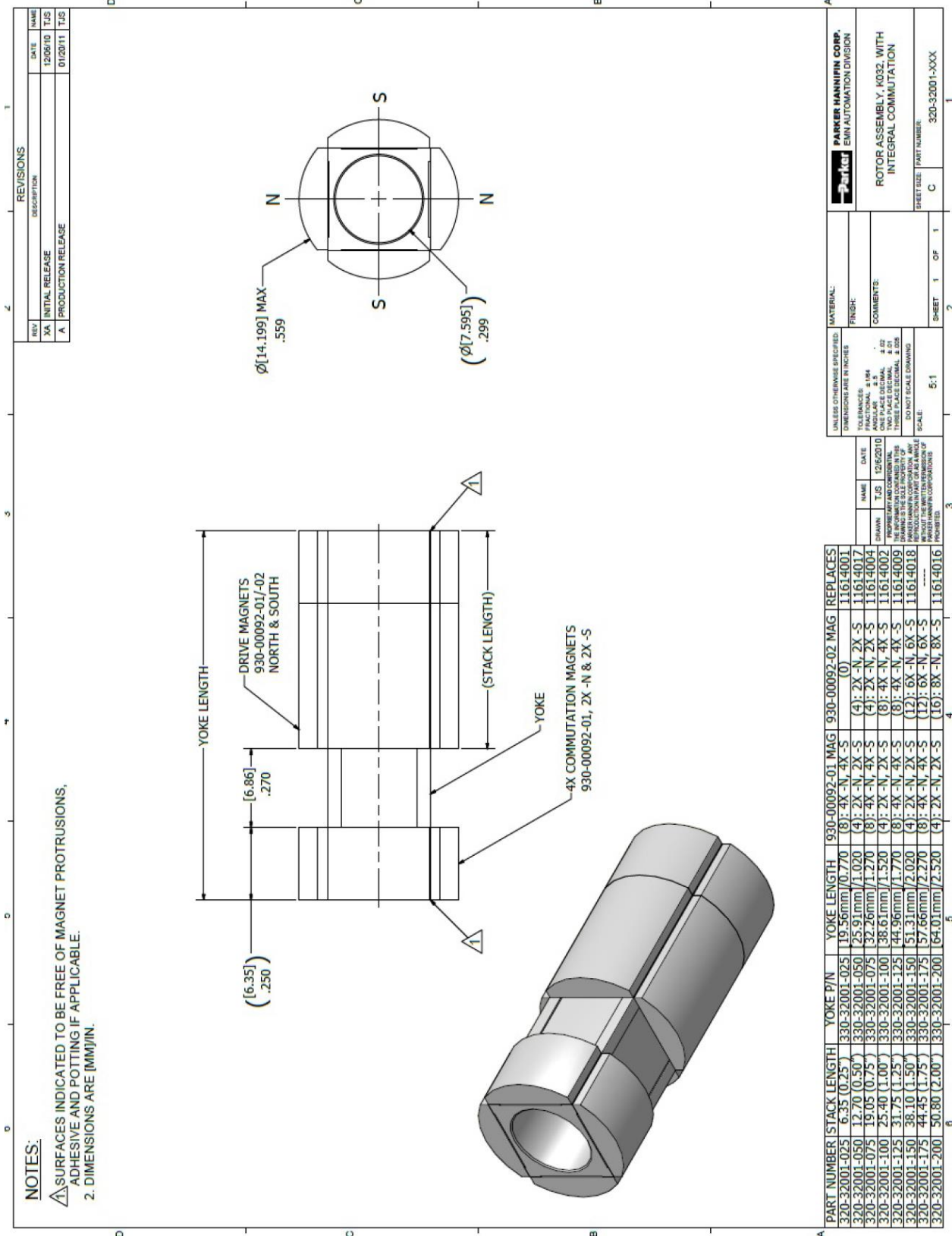

REV		DATE		NAME	
DESCRIPTION					
XX	INITIAL RELEASE	12/05/10	TJS		
A	PRODUCTION RELEASE	01/20/11	TJS		

REVISIONS

1

2

3

4

5

6

7

8

9

10

11

12

13

14

15

16

17

18

19

20

21

22

23

24

25

26

27

28

29

30

31

32

33

34

35

36

37

38

39

40

41

42

43

44

45

46

47

48

49

50

51

52

53

54

55

56

57

58

59

60

3.3.5. K044

NOTES

- MOTOR SUPPLIED AS TWO COMPONENTS: ROTOR & STATOR
- MAXIMUM WINDING TEMPERATURE TO BE 155 °C
- DIGIT INDICATES THAT WINDING GETS NO INTEGRAL COMMUTATION.

REVISIONS

REV	DESCRIPTION	DATE	APPROVED
A	INITIAL RELEASE	8/10/00	J. DEVERDITS

FOR ROTOR LENGTH USE STACK + 762 CENTERED

K044 **XXX** **X** **X** **1**

MOTOR DESIGNATION STACK CODE WINDING NUMBER CONNECTION SEE NOTE 3

STACK CODE	STACK LENGTH X
025	6.35
050	12.7
075	19.05
100	25.4
125	31.75
150	38.1
175	44.45
200	50.8
225	57.15
250	63.5
275	69.85
300	76.2
325	82.55
350	88.9
375	95.25
400	101.6

ITEM NO.	QTY	DESCRIPTION	VENDOR	PART NUMBER
1	1	ROTOR ASSEMBLY - GENERIC - WITHOUT INTEGRAL COMM.	BAYSIDE	11500XXX
2	1	STATOR - ASSY - GENERIC - 044, WITHOUT INTEGRAL COMM.	BAYSIDE	044XXX-XXI

BAYSIDE MOTION GROUP
PORT WASHINGTON, NEW YORK, 11050

044 KIT ASSY
WITHOUT INTEGRAL COMM

SCALE:	FSCM NO.	DRAWING NO.	SHEET:
1:500	96559	K044XXX-XXI	2 OF 2

3.3.6. K044 – with Hall effect sensor

REVISIONS			
REV	DESCRIPTION	DATE	APPROVED
A	INITIAL RELEASE	8/10/00	J. DEVERDITS

NOTES

- MOTOR SUPPLIED AS TWO COMPONENTS: ROTOR & STATOR
- MAXIMUM WINDING TEMPERATURE TO BE 155 °C
- DIGIT INDICATES THAT WINDING GETS NO INTEGRAL COMMUTATION.

STACK CODE	STACK LENGTH X
025	6.35
050	12.7
075	19.05
100	25.4
125	31.75
150	38.1
175	44.45
200	50.8
225	57.15
250	63.5
275	69.85
300	76.2
325	82.55
350	88.9
375	95.25
400	101.6

ITEM NO.	QTY REQ'D	DESCRIPTION	VENDOR	PART NUMBER
1	1	ROTOR ASSEMBLY - GENERIC WITH INTEGRAL COMMUTATION	BAYSIDE	12168XX
2	1	STATOR - ASSY GENERIC 044 WITH INTEGRAL COMM	BAYSIDE	044XX-XX2

BAYSIDE MOTION GROUP FORT WASHINGTON, NEW YORK, 11050	
044 KIT ASSY WITH INTEGRAL COMM	
SCALE: 1:500	SHEET: 1 OF 2
SIZE: A	DRAWING NO. K044XX-XX2
FSCM NO. 96559	REV. A

3.3.7. K064

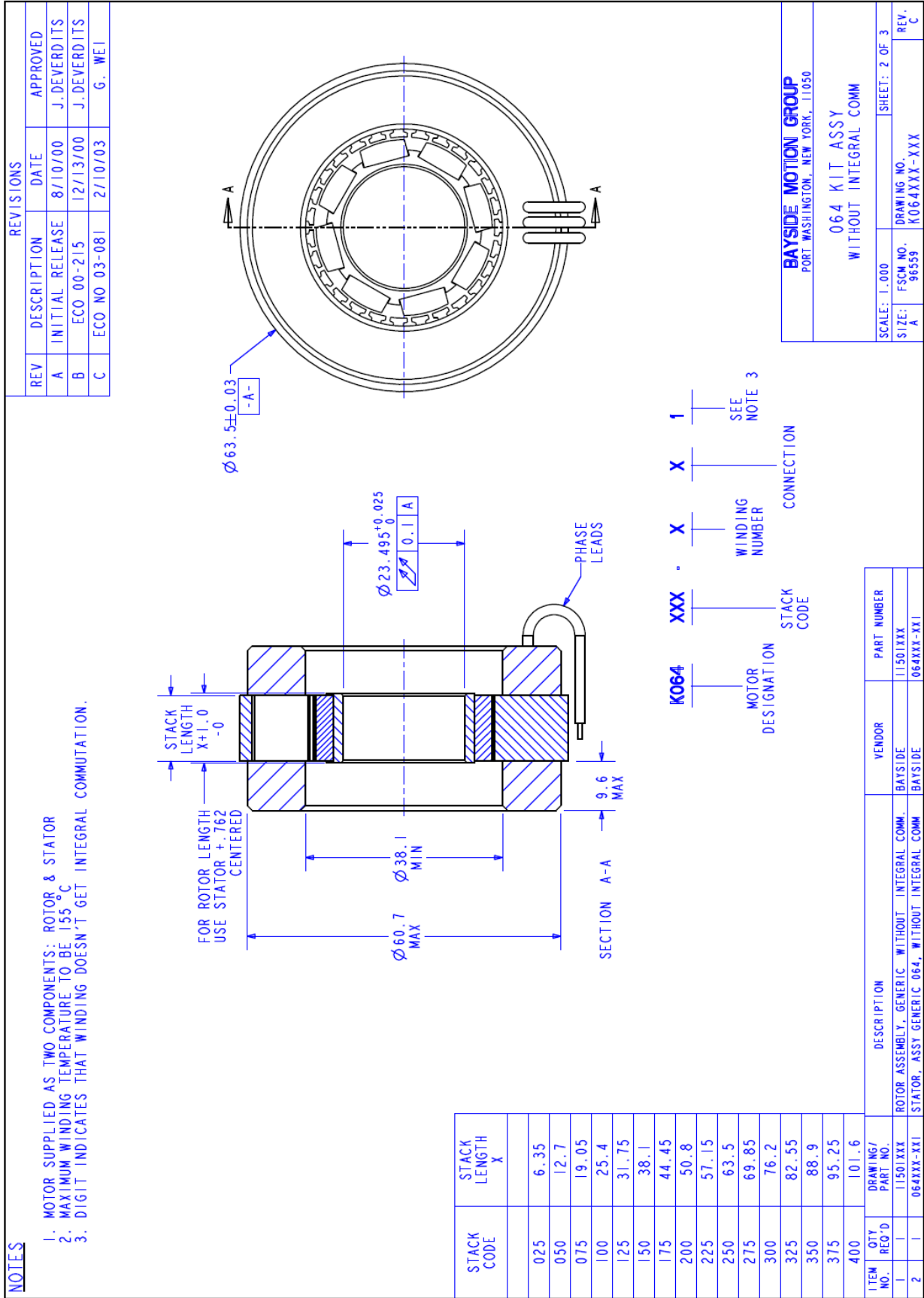

3.3.8. K064 – with Hall effect sensor

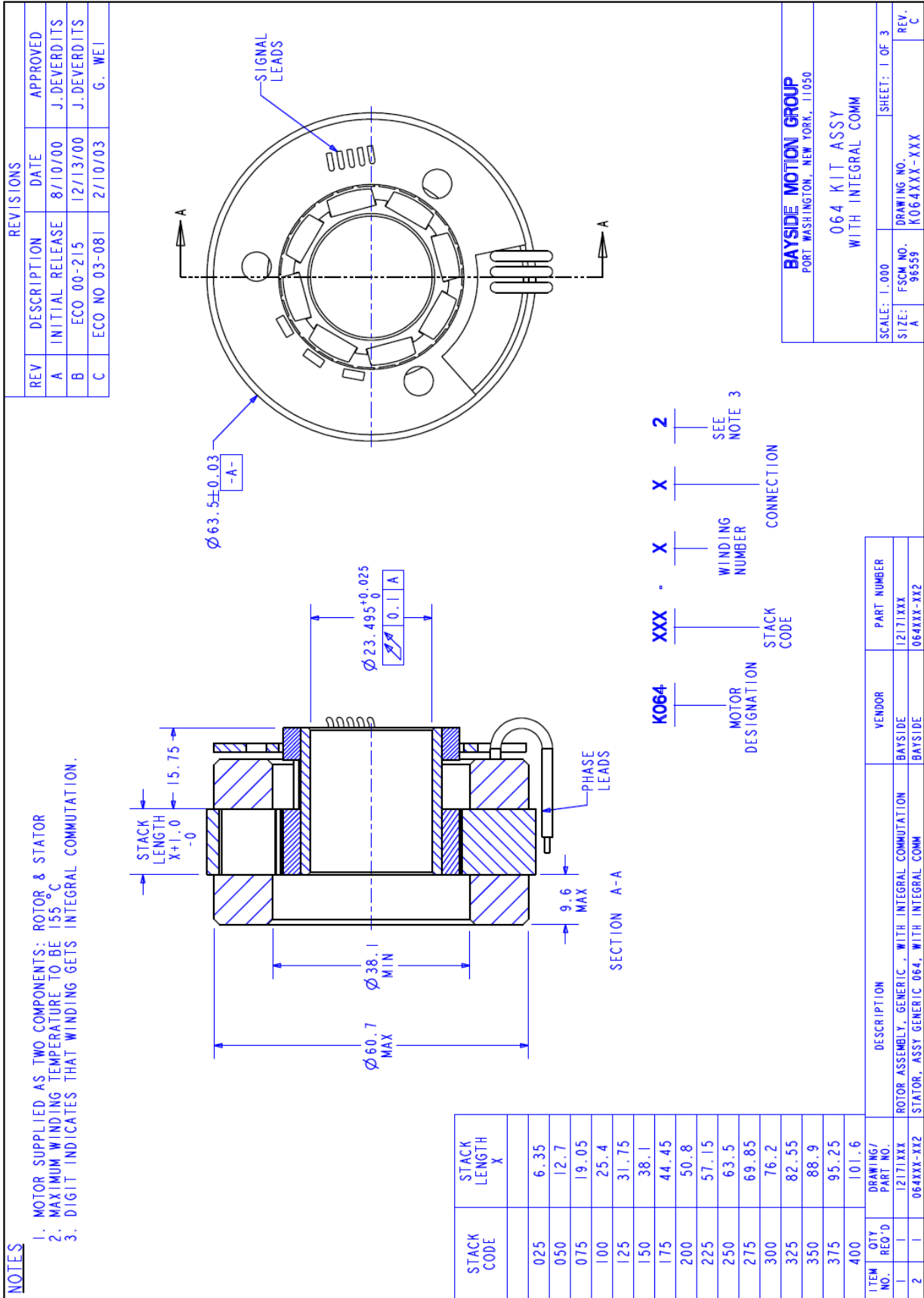

3.3.9. K089

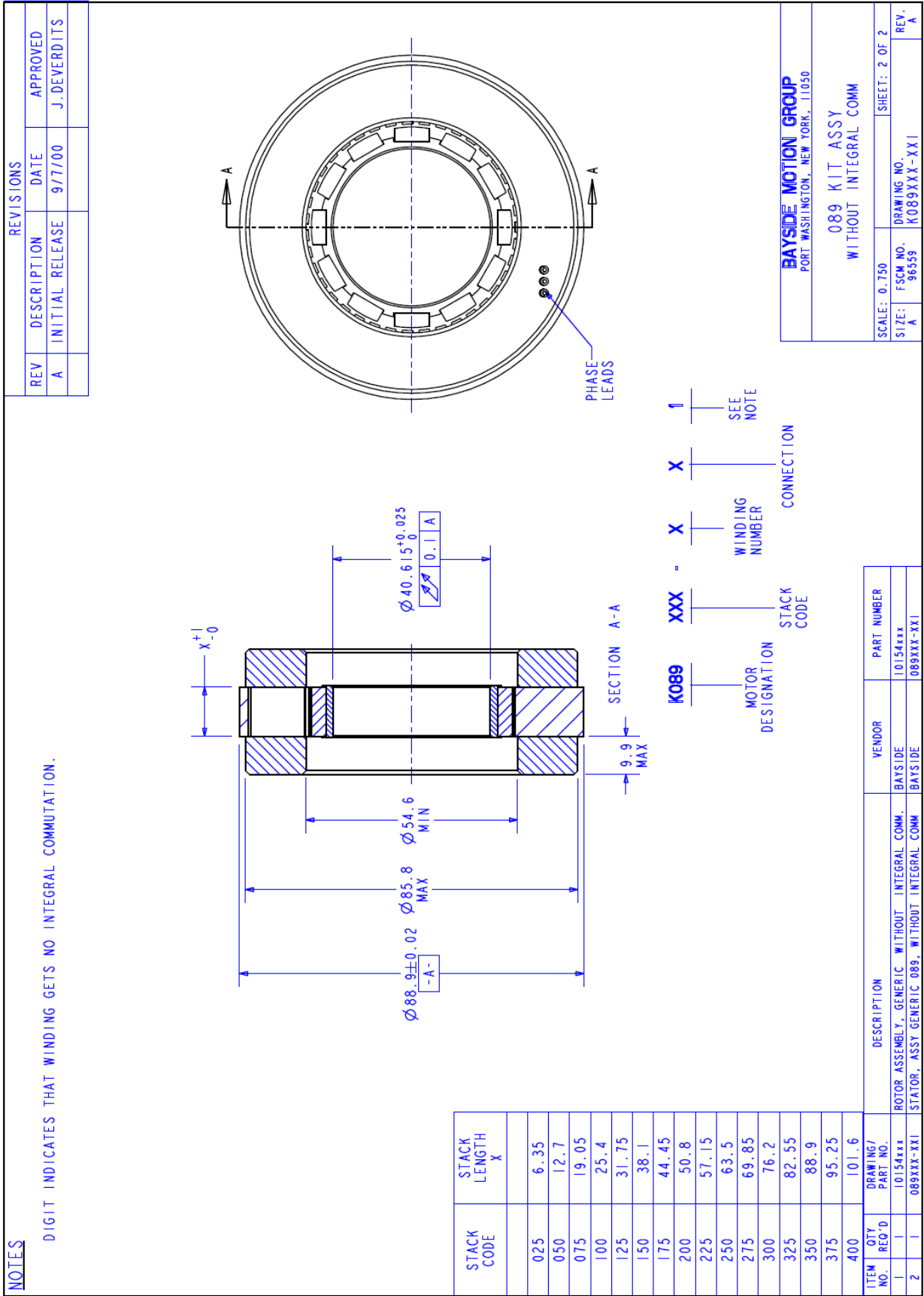

3.3.10. K089 – with Hall effect sensor

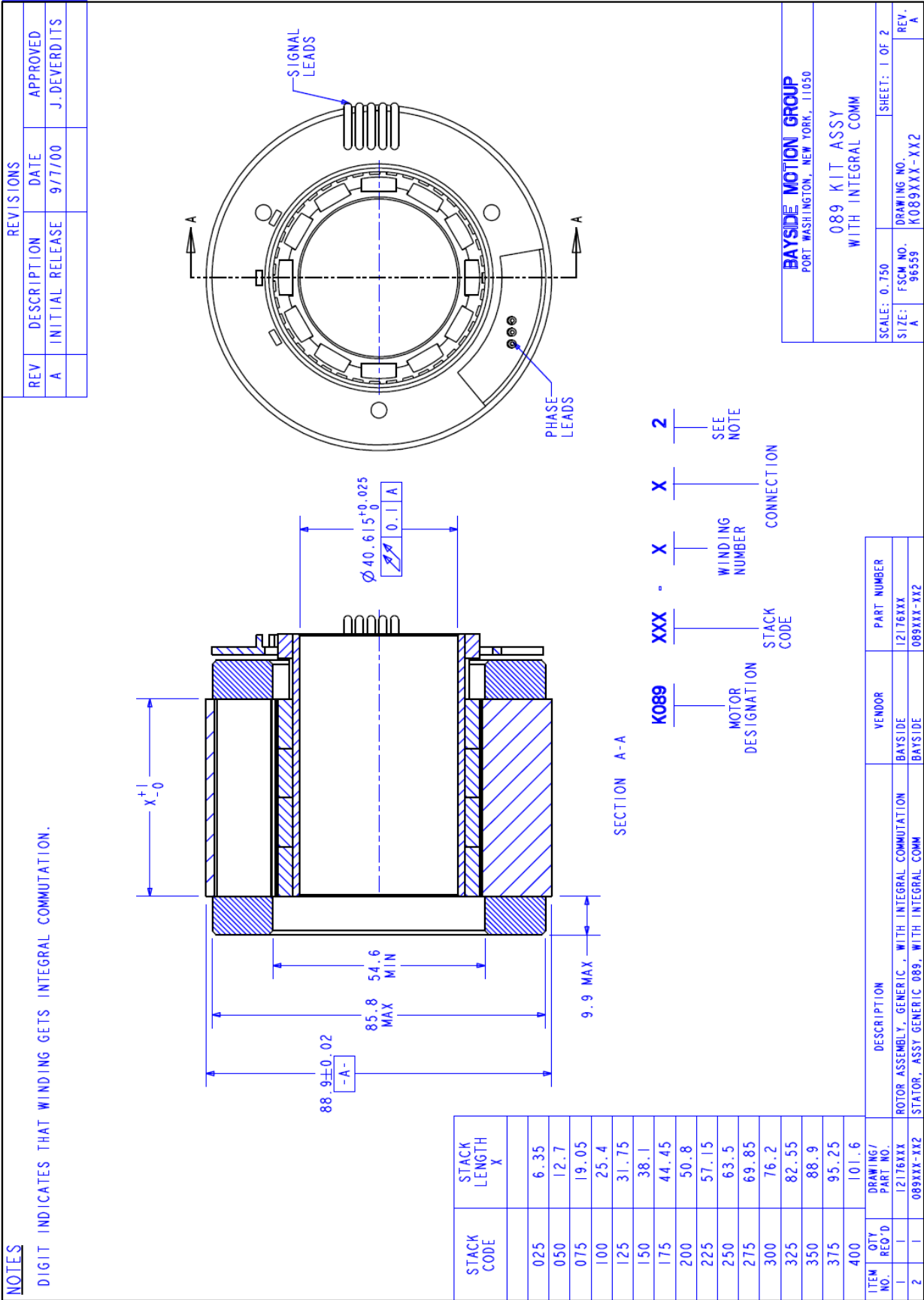

3.3.11. K178

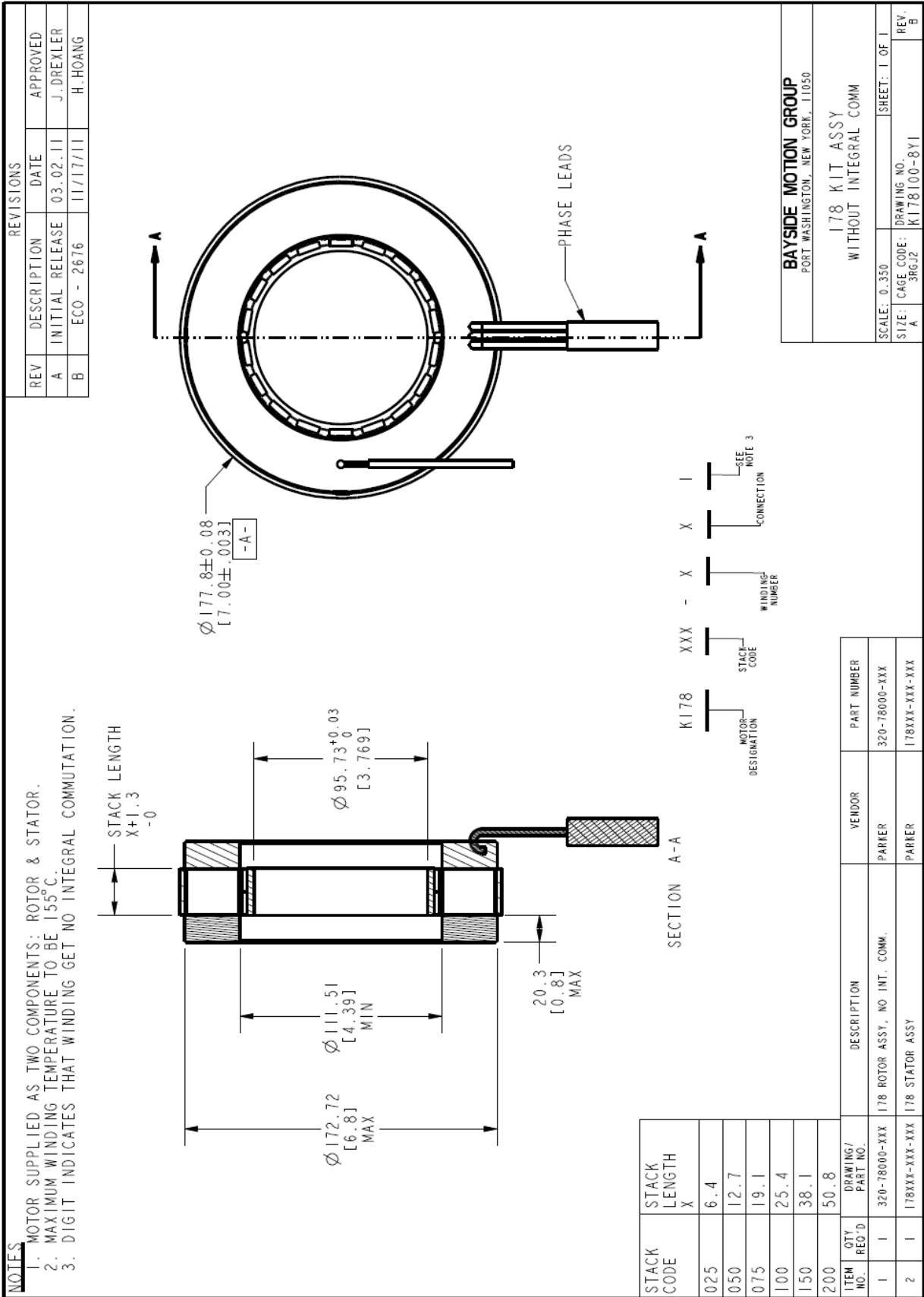

3.4. Motor mounting recommendations

	<p><u>Warning</u> : The recommendations in this chapter are general. It is the integrator responsibility to check if it complies with his application and to chose and define the correct way to integrate the kit according to his application, all the regulations and standards applicable.</p>
---	--

3.4.1. Frame recommendations

	<p><u>Warning</u> : The integrator has the entire responsibility to design and prepare the housing, the shaft, connection box, the support, the coupling device, shaft line alignment, and shaft line balancing.</p>
---	--

Machine design must be even, sufficiently rigid, precise and shall be dimensioned as to avoid vibrations due to resonances. Integrator bears the entire responsibility for choice of the key components, such as bearing, encoder, electric connection and mechanical parts design.

	<p><u>Warning</u> : A grade A motor (according to IEC 60034-14) well-balanced, may exhibit large vibrations when installed in-situ arising from various causes, such as unsuitable foundations, reaction of the driven motor, current ripple from the power supply, etc. Vibration may also be caused by driving elements with a natural oscillation frequency very close to the excitation due to the small residual unbalance of the rotating masses of the motor. In such cases, checks should be carried out not only on the machine, but also on each element of the installation. (See ISO 10816-3).</p>
---	--

	<p><u>Warning</u> : A bad setting of the electronic control of the close loop (gain too high, incorrect filtering ...) can occur an instability of the shaft line, vibration or/and breakdown - . Please consult us</p>
---	---

3.4.2. Servomotor typical construction

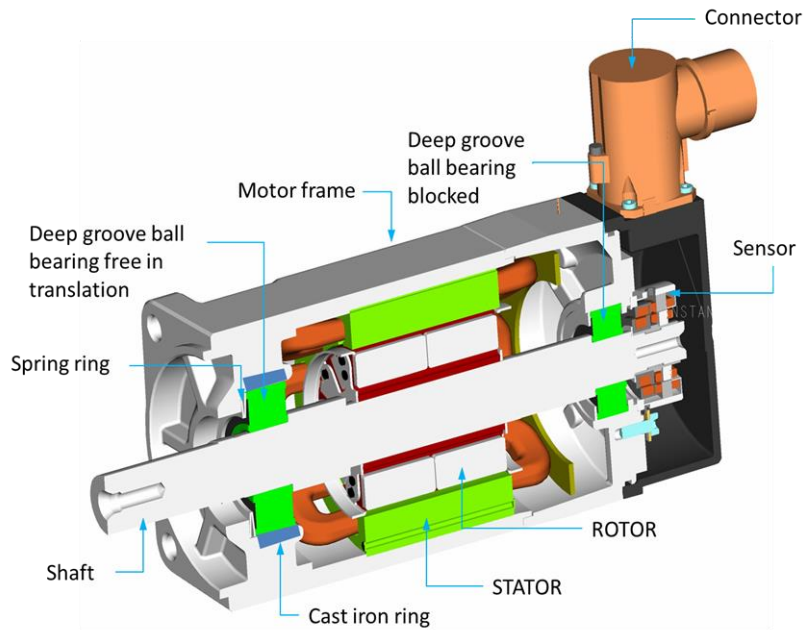

3.4.3. Bearings recommendation

The arrangement bearings choice is a key point for the motor design. It depends on speed, load and life time needed. We recommend to contact bearings suppliers technical departments to check the arrangement.

	<p><u>Warning</u> : When motor runs, the temperature increases (up to 120°C on the rotor), so use springs or spring rings on one bearing to accept shaft dilatation and to create a preload..</p>
	<p><u>Warning</u> : When motor runs, temperature increases (up to 120°C on the rotor), so we recommend to use bearings with C3 clearance.</p>

3.4.4. Mounting recommendations

A number of methods are used to mount the stator and rotor assemblies to the customer product. The method chosen largely depends on the product design, performance requirements (torque, velocity, temperature, etc.) and the manufacturing capabilities of the user.

The following are some brief design consideration notes for your kit motor. Please contact our application engineering group if you require any assistance.



3.4.4.1. Stator

Housing:

The K Series are typically housed within an aluminum cylinder. And a motor flange is used to fix the kit onto the mounting plate (see minimal dimension in §3.5 Natural cooled motor).

Recommended wall thickness of the aluminum cylinder are the following:

K032:	thickness 6.35 mm
K044:	thickness 6.35 mm
K064:	thickness 6.35 mm
K089:	thickness 6.35 mm
K178:	thickness 12.7 mm

Dimensions of the motor flange are the following:

K032:	152.4 mm X 152.4 mm X 12.7 mm
K044:	152.4 mm X 152.4 mm X 12.7 mm
K064:	152.4 mm X 152.4 mm X 12.7 mm
K089:	203.2 mm X 203.2 mm X 12.7 mm
K178:	228.6 mm X 228.6 mm X 12.7 mm

It is recommended that a banking step be incorporated at the bottom of the hole to assure accurate and repeatable location of the stator (respect insulation and creepage distances). Alternately, a non-ferrous “plug” can be used to provide a banking surface, which can be removed once the stator is fixed in place.

For volume production, a jig should be fabricated that will assure that the stator is located in the same position for each assembly. The yellow dot on the stator provides an index point for accomplishing this. This will eliminate the need to perform mechanical commutation alignment at final assembly.

In designing the housing, provide a means for the stator lead wires (three) and the commutation Hall sensor PCB wires (five) to extend outside of the housing without interfering with the rotor/shaft assembly. In addition, do not mix feedback wires with motor wires to avoid EMI (electromagnetic interference). EMI risk to set default the drive. So, careful to separate sensor and motor wires.

Stator Assembly:

Assemble stator in housing or sleeve with the following locational clearances:

- Diameter up to 127 mm : 0.025 mm to 0.127 mm diametrical clearance.
- Diameter over 127 mm : 0.050 mm to 0.254 mm diametrical clearance.

Thermal performances are given for medium diameter clearances. So, the contact between housing and stator (lamination stack) has to be as close as possible. Therefore, the thermal resistance induced will be minimized

Do not force stator in position. This may damage or deform stator.

The stator is typically held in position with adhesive for a permanent assembly with adhesive, Loctite #325 with activator #7074 or equivalent

Rotor

Except for the smaller motors (K032 and K044), the ID of the rotor is usually larger than the shaft diameter. An adapter sleeve (steel or aluminum) allows the rotor to be mounted to the shaft. The rotor/sleeve assembly must be positioned on the shaft such that the magnets are located in line with the stator assembly laminations.

If the version in which the commutation PCB assembly is bonded to the end turns is being used, the commutation magnets must be located in proper proximity to the Hall sensors on the PCB. Shows two methods for holding the rotor/sleeve on the shaft, either with adhesive or by using a spring pin and retaining ring.

When using the adhesive method, a shoulder should be provided on the shaft to properly locate the rotor/sleeve assembly.

When using the spring pin/retaining ring method, a slot must be provided in the sleeve that will engage the spring pin in the shaft, thus properly locating the rotor/sleeve assembly.

During assembly, be sure that the pin and slot are fully engaged.

Assemble rotor to shaft with a locational clearance fit of 0.013 mm to 0.038 mm diametrical clearance.

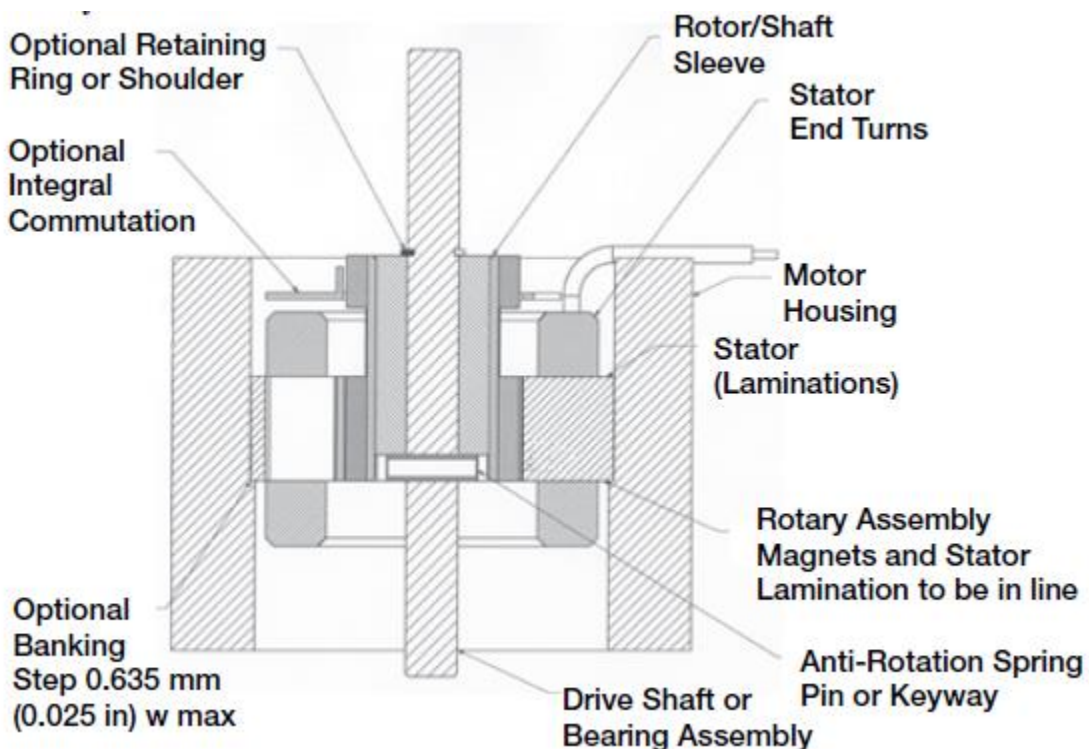

Note: The following adhesives can be used for rotor and stator assembly (see figure below). It is the integrator responsibility to check if it complies with his application and to define the correct adhesives.

Loctite #325

Activator #7074

Loctite #609

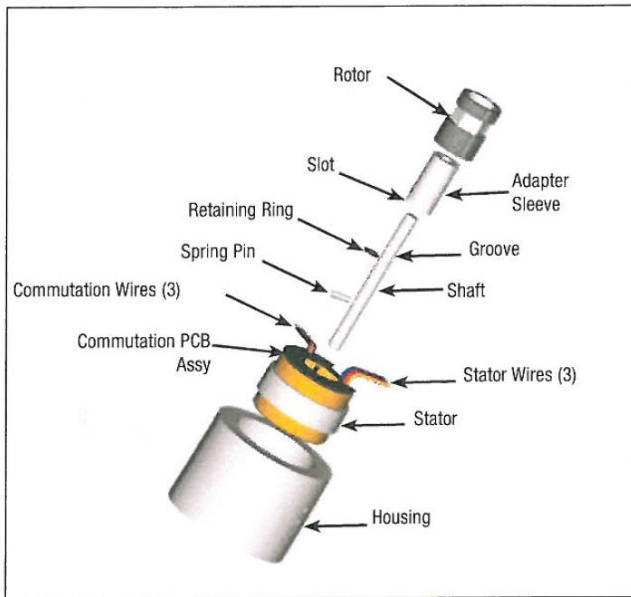

Spring Pin / Retaining Ring Method

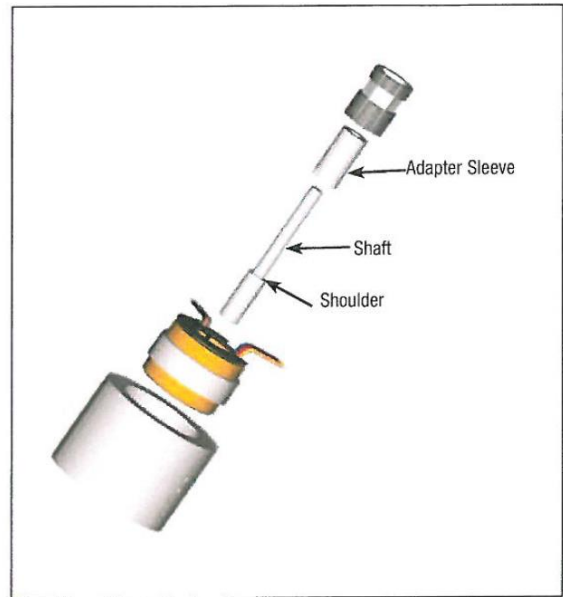

Shoulder / Adhesive Method

Final Assembly:

Rotor magnets to be in line with stator laminations and concentric to stator lamination I.D. within 0.127 mm MAX.

	<p>Caution : Rotor assembly magnets are powerful and fragile! Do not place near magnetically sensitive material. Do not place near other ferromagnetic materials such as iron, steel and nickel alloys. Strong uncontrolled attraction may damage magnets on contact.</p>
---	--

	<p>Caution : When assembling the rotor into the stator, high radial forces will be experienced, which can cause the magnets to “crash” into the stator and be damaged and / or cause bodily injury!</p>
---	--

The following precautions should be taken:

- Wrap the rotor with a thin (0.12 mm thick) Mylar sleeve which fill the air gap between the rotor and stator during assembly and can be easily removed when assembly is complete.
- Support the rotor and stator assemblies in a fixturing arrangement which will prevent radial motion while the two assemblies are being mated.



Example:

1. Hold the rotor / shaft / product assembly in a machine tool vise on the base of an arbor press.
2. Fasten the stator assembly to the vertical moving member of the arbor press, away from the stator.
3. Slowly lower the stator assembly around the rotor / shaft / product assembly.
4. Tighten all fasteners to complete assembly.
5. Remove Mylar shim and check for rotational clearance.



Caution : The motor has to be painted in order to evacuate the losses as much as possible. Recommended paint : **black color**

Additional information can be obtained with the following link:

http://www.parkermotion.com/products/Rotary_Servo_Motors_7057_30_32_80_567_29.html

[VIDEO: How to Integrate Frameless Kit Motors](#)

3.4.5. Design Compliance

The integrator is responsible for compliance with directives, regulations and standards. Nonexhaustively, the integrator has to certify the motor design in order to be conformed to the guide lines (nonexhaustively).

- Low Voltage Directive 2014/35/EU
- RoHs Directive 2011/65/CE
- EMC Directive 2004/108/CE

The motor must comply with the IEC60034 standard

The heating of the motor must meet the requirements of the class F insulation (cf. IEC 60034-1)

3.4.6. Dielectric test

Each motor must undergo once completely, a dielectric test (Routine test) in accordance with the standard IEC 60034-1 (i.e. 700 V during 1 min for <100 Vac or 1500 V during 1 min for 230 Vac).

3.4.7. Earthing

A protective earth cable with the appropriate cable diameter must connect the motor stator to the grounding (cf. standards: NF C15-100, CEI 60364-1, IEC 60204-1).

Section of phases conductors, S [mm ²]	Corresponding minimal cross-section of earthing conductor, S_p [mm ²]
$S \leq 16$	S
$16 < S \leq 35$	16
$S > 35$	$0.5S$

3.4.8. Minimum clearances for insulation and creepage distances

Depending on the pollution degree and the voltage in use, the minimum clearances for insulation and creepage distances must meet the standard EN 60664-1.

It is the integrator's responsibility to take the needed actions to comply with these distances or by adding proper additional insulation.

For information:

- *Pollution degree 1.* No pollution or only dry, nonconductive pollution occurs. The pollution has no influence (example: sealed or potted products).
- *Pollution degree 2.* Normally only nonconductive pollution occurs. Occasionally a temporary conductivity caused by condensation must be expected (example: product used in typical office environment).
- *Pollution degree 3.* Conductive pollution occurs, or dry, nonconductive pollution occurs that becomes conductive due to expected condensation (example: products used in heavy industrial environments that are typically exposed to pollution such as dust).
- *Pollution degree 4.* Pollution generates persistent conductivity caused, for instance, by conductive dust or by rain or snow.



Minimum clearances for insulation:

Voltage rms	Required impulse withstand voltage V	Minimum clearances in air in millimeters up to 2000 m above sea level							
		Case A (inhomogeneous field)				Case B (homogeneous field)			
		Pollution degree				Pollution degree			
		1 mm	2 mm	3 mm	4 mm	1 mm	2 mm	3 mm	4 mm
50V from 100V to 250V up to 500V	600	0,06	0,2	0,8	1,6	0,06	0,2	0,8	1,6
	1500	0,5	0,5	0,8	1,6	0,3	0,3	0,8	1,6
	2000	1	1	1	1,6	0,45	0,45	8	1,6

N.B. Please refer to the standard EN 60664-1 for more information.

Minimum creepage distances for equipment subject to long-term stresses

Voltage rms	Creepage distances in millimeters									
	Pollution degree									
	1	2 Material group			3 Material group			4 Material group		
	mm	I mm	II mm	III mm	I mm	II mm	III mm	I mm	II mm	III mm
50	0,18	0,6	0,85	1,2	1,5	1,7	1,9	2	2,5	3,2
100	0,25	0,71	1	1,4	1,8	2	2,2	2,4	3	3,8
160	0,32	0,8	1,1	1,6	2	2,2	2,5	3,2	4	5
200	0,42	1	1,4	2	2,5	2,8	3,2	4	5	6,3
250	0,56	1,25	1,8	2,5	3,2	3,6	4	5	6,3	8
320	0,75	1,6	2,2	3,2	4	4,5	5	6,3	8	10
400	1	2	2,8	4	5	5,6	6,3	8	10	12,5
500	1,3	2,5	3,6	5	6,3	7	8	10	12,5	16

N.B. Please refer to the standard EN 60664-1 for more information.

3.4.9. Ground continuity compliance

The Motors must meet the standards IEC 60204-1.

Continuity of the grounding circuit : On each complete unit, the resistance between any conductive point and the grounding conductor shall not exceed than 100 mΩ. This test shall be performed before the dielectric tests. (EN 60204-1: Safety of the machine)

3.4.10. Protection rating

cf. IEC 60529 and IEC 60034-5

The K Series Kit Motors show an IP00 protection rating. It is the integrator's responsibility to ensure the appropriate protection rating depending on the use of the motor (protection against electric shocks of persons, protection against dust, liquids, solid particles, ...)



3.4.11. Overspeed test

A qualification test at 20% above the rated speed during at least 1 min, must be carried out according to the standard IEC 60034-1.

3.4.12. EMC Directive

cf. guide lines 2004-108 CE and standard IEC 61800-3

It is the integrator's responsibility to ensure that the motor and drive in use comply with the EMC directive.

3.4.13. Other regulation requirements

The previous list is not exhaustive and all the other requirements in the regulation standard and directives must be checked by the integrator.

3.5. Natural cooled motor

In compliance with the IEC 60034-1 standards: the ambient air temperature shall not be less than **-15°C** and more than **40°C**.

	<p>K Series Kit are housed in a motor frame detailed in § 3.4.4.1 Stator</p>
---	--

	<p><u>Warning:</u> To reach the motor performances calculated, the complete motor must thermally well connected to a aluminium flange with the following dimensions:</p> <ul style="list-style-type: none"> - K032 : 25.4 cm×25.4 cm×0.635 cm (S=1355 cm²) - K044 : 25.4 cm×25.4 cm×0.635 cm (S=1355 cm²) - K064 : 25.4 cm×25.4 cm×0.635 cm (S=1355 cm²) - K089 : 30.48 cm×30.48 cm×1.27 cm (S=2013 cm²) - K178 : 40.64 cm×40.64 cm×2.54cm (S=3716 cm²)
---	--

	<p><u>Caution:</u> the ambient air temperature shall not exceed 40°C in the vicinity of the motor flange</p>
---	--

	<p><u>Warning:</u> A significant part of the heat produced by the motor is evacuated through the flange.</p> <ul style="list-style-type: none"> • if the air is not able to circulate freely around the motor, • if the motor is mounted on a surface that dissipates not well the heating (surface with little dimensions for instance), • if the motor is thermally isolated, • if the motor is mounted on a warm surface (mounted on a gearbox for instance), <p>then the motor has to be used at a torque less than the rated torque.</p>
---	---

3.6. Power Electrical Connections

3.6.1. Wires sizes

	<p>In every country, you must respect all the local electrical installation regulations and standards.</p>
---	--

Not limiting example in France: NFC 15-100 or IEC 60364 as well in Europe.

	<p>Cable selection depends on the cable construction, so refer to the cable technical documentation to choose wire sizes</p>
---	--

	<p>Some drives have cable limitations or recommendations; please refer to the drive technical documentation for any further information.</p>
---	--

Cable selection

	<p>At standstill, the current must be limited at 80% of the low speed current I_0 and cable has to support peak current for a long period. So, if the motor works at standstill, the current to select wire size is $\sqrt{2} \times 0.8 I_0 \cong 1,13 \times I_0$.</p>
---	--

Sizes for H07 RN-F cable, for a 3 cores in a cable tray at 30°C max

Section [mm ²]	I _{max} [A _{rms}]
1.5	17
2.5	23
4	31
6	42
10	55
16	74
25	97
35	120
50	146
70	185
95	224
120	260
150	299
185	341
240	401
300	461



Example of sizes for H07 RN-F cable :

Conditions of use:

Case of 3 conductors type H07 RN-F: **60°C maximum**

Ambient temperature: 30°C

Cable runs on dedicated cables ways

Current limited to 80%*I₀ at low speed or at motor stall.

Example:

I₀=100 Arms

Permanent current at standstill : 80 Arms

Max permanent current in the cable = 113 Arms

Cable section selection = 35mm² for a 3 cores in a cable tray at 30°C max.

You also have to respect the Drive commissioning manual and the cables current densities or voltage specifications

3.6.2. Conversion Awg/kcmil/mm²:

Awg	kcmil	mm ²
	500	253
	400	203
	350	177
	300	152
	250	127
0000 (4/0)	212	107
000 (3/0)	168	85
00 (2/0)	133	67.4
0 (1/0)	106	53.5
1	83.7	42.4
2	66.4	33.6
3	52.6	26.7
4	41.7	21.2
5	33.1	16.8
6	26.3	13.3
7	20.8	10.5
8	16.5	8.37
9	13.1	6.63
10	10.4	5.26
11	8.23	4.17
12	6.53	3.31
14	4.10	2.08
16	2.58	1.31
18	1.62	0.82
20	1.03	0.52
22	0.63	0.32
24	0.39	0.20
26	0.26	0.13
28	0.16	0.08

3.6.3. Motor cable length

For motors windings which present low inductance values or low resistance values, the own cable inductance, respectively own resistance, in case of large cable length can greatly reduce the maximum speed of the motor. Please contact PARKER for further information.



	<p><u>Caution:</u> It might be necessary to fit a filter at the servo-drive output if the length of the cable exceeds 25 m. Consult us.</p>
---	---

3.6.4. Ground connection

	<p><u>DANGER:</u> For the safety, you need to connect stator to the ground. Consult local regulation to choose the cross section and to know resistance limits to check ground continuity between frame and ground wire.</p>
---	--

3.6.5. Motor cable

The motor cables are flexible, so cables can take any direction.
The electrical connection on motor in kit version is realized by high performance cable.
The motor cable section depends of the motor current level.

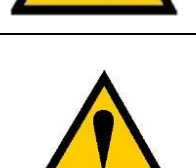
	<p><u>Caution:</u> The motor cables are designed for high current density, so cable surface can reach temperatures exceeding 100°C.</p>
	<p><u>Caution:</u> The wiring must comply with the drive commissioning manual and with recommended cables. <u>Caution:</u> Section motor cable is lower than commissioning section cable between motor and drive due to high performance motor cable design. Do not take the same cable section than motor ones.</p>
	<p><u>Attention:</u> Do not mix feedback wires with motor wires to avoid EMI (electromagnetic interference). EMI risk to set default the drive. So, careful to separate resolver and motor wires.</p>



3.6.6. Motor Lead Cross Section [Awg]

Motor	Winding					
	4Y	6Y	7Y	8Y	9Y	EY
K032050			25	26		28
K032100			25	26		28
K032200			25	26		28
K044050			23	24		26
K044100			23	24		26
K044200			23	24		26
K064050				22	23	24
K064100				22	23	24
K064200				22	23	24
K089050		19	20		22	
K089100		19	20		22	
K089200	17		20		22	
K178050		14		16		18
K178100				16	17	18
K178200				16	17	18

3.7. Feedback system

An angular position sensor is often used to run the motor and it depends on the drive functionalities and application. A drive with a sensorless mode needn't a feedback system.

A classic position sensor is an encoder, a commutation Hall effect sensor and resolver.

	<p>Attention: Do not mix feedback wires with motor wires to avoid EMI (electromagnetic interference). EMI risk to set default the drive. So, careful to separate resolver and motor wires.</p>
--	--

3.7.1. Commutation Hall effect sensor

The motor can be delivered with a commutation sensor allowing to control the current in the motor.

Signal Timing

Motor Signal

Power Leads	Forward
SEN X	Red
SEN Y	Black
SEN Z	White

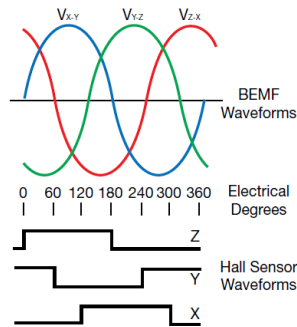

Commutation Assembly

Sensor Leads	Forward	Rearward
SEN Z	Brown	Brown
SEN Y	Green	White
SEN X	White	Green
+5 V	Violet	Violet
Ground	Gray	Gray

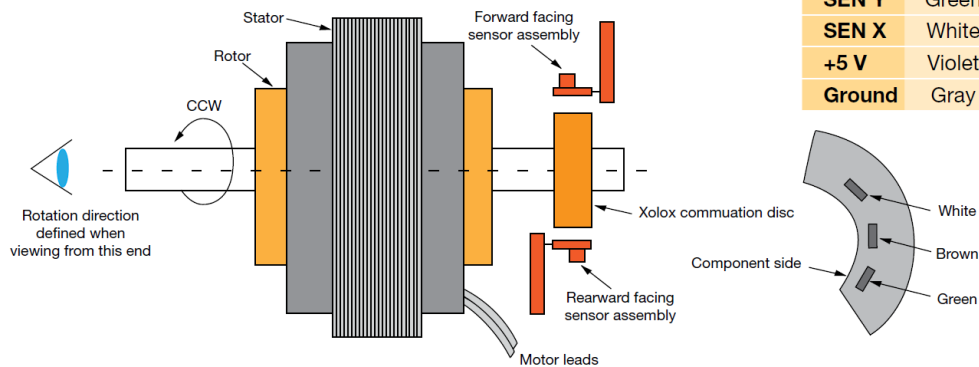

3.7.2. Resolver

3.7.2.1. Overview

A resolver is an angular position sensor. It is used to determine rotor position. Its signals are processed by the drive in order to control the stator currents, the speed and the position.

The resolver is a high precision device and must be wired and mounted with care.



3.7.2.2. Example of resolver mounting

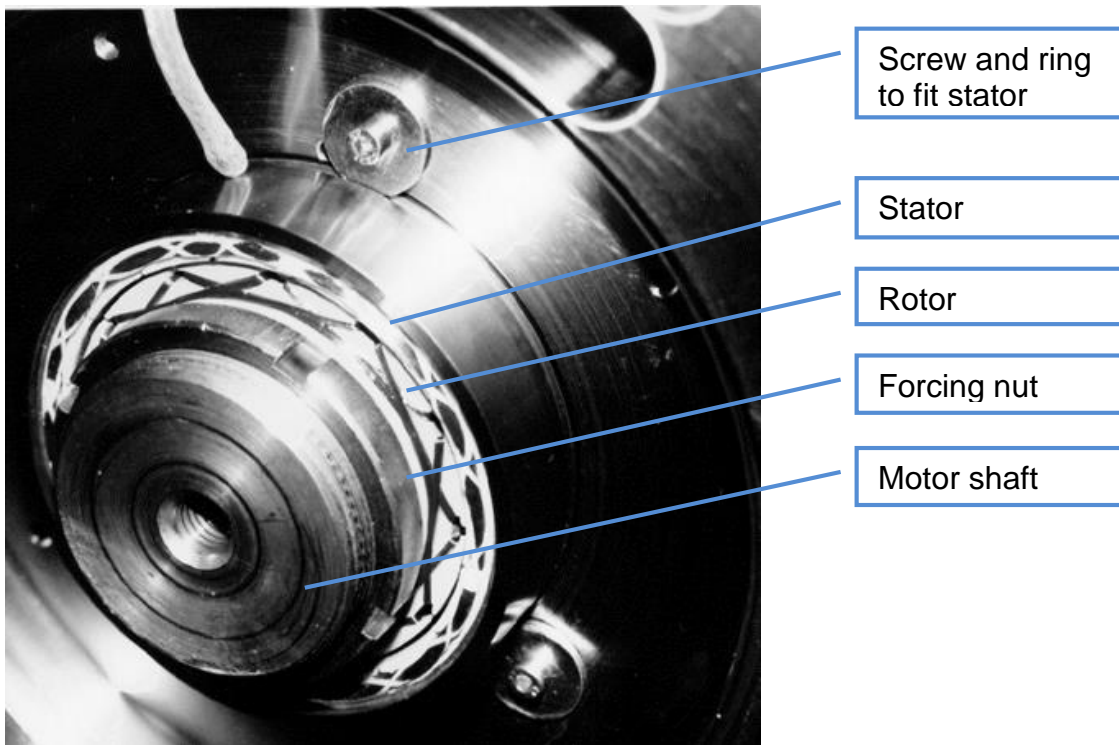

3.7.2.3. Resolver characteristics

Kit associated	K032	K044	K064 & K089	K178
Parker part number	220005P1000	220005P1001	220005P1002	220005P1003
Electrical specification	Values @ 8 kHz			
Polarity	2 poles			
Input voltage	7 Vrms			
Input current	70mA maximum	86mA maximum		56mA maximum
Zero voltage	20mV maximum			
Encoder accuracy	$\pm 10'$ maxi			
Ratio	$0,5 \pm 5 \%$			
Output impedance (primary in short circuit whatever the position of the rotor)	Typical $120 + 200j \Omega$			Typical $95 + 180j \Omega$
Dielectric rigidity (50 – 60 Hz)	500 V – 1 min			
Insulation resistance	$\geq 10M\Omega$	$\geq 100M\Omega$		
Rotor inertia	$\sim 6 \text{ g.cm}^2$	$\sim 30 \text{ g.cm}^2$	$\sim 123 \text{ g cm}^2$	
Operating temperature range	-55 to +155 °C			

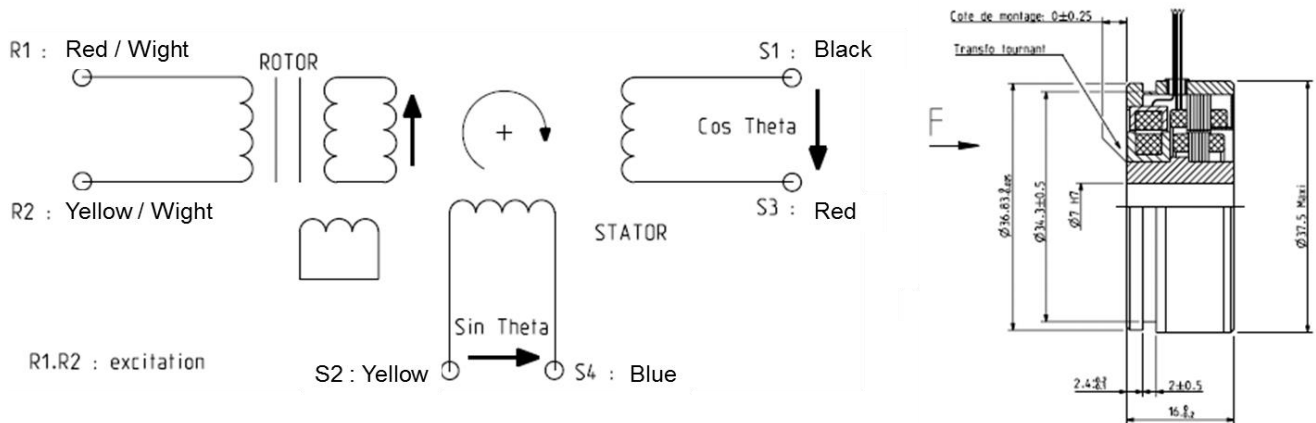

$$\begin{array}{l|l|l}
 S1 = \text{Cos} - & S2 = \text{Sin} - & R1 = \text{excitation} + \\
 S3 = \text{Cos} + & S4 = \text{Sin} + & R2 = \text{excitation} -
 \end{array}$$

Rotor is clock wise rotation viewed from mounting flange end (F view)



Resolvers are single pole pair resolvers: they give absolute position on 1 motor rotation.



For easy kit integration and electrical checking a connector is recommended for the signals.



3.7.2.4. Cables and connectors associated to the resolver

To connect the motor with a connector M23 to PARKER drive : AC890, COMPAX3 or SLVD, you can use complete cable with part number on the tabs below.

The "xxx" in the part number must be replaced by the length in meter.

Ex : for 20m cable, "xxx" = 020.

Feedback Sensor	Cable reference for AC890	Cable reference for COMPAX3	Cable reference for SLVD
Resolver	CS4UA1F1R0xxx	CC3UA1F1R0xxx	CS5UA1F1R0xxx

For other drive, you can assembly cable and plug by soldering with part number on the tab below:

Feedback Sensor	Cable reference	Plug reference
Resolver	6537P0047	220065R4621

3.7.2.5. Resolver setting

During the setting procedure, it is strictly necessary to respect the 3 following conditions:

- The rotor must be able to rotate freely. The maximum friction torque on the rotor must not exceed 1% of the motor permanent torque.
- The cooling circuit has to be in use.
- The operator must be able to reach the resolver stator and to manually turn it and lock it (access to the locking screws).

Look at the drive instruction manual for the setting procedure details.

3.7.2.6. Resolver drawings Resolver part number 220005P1000

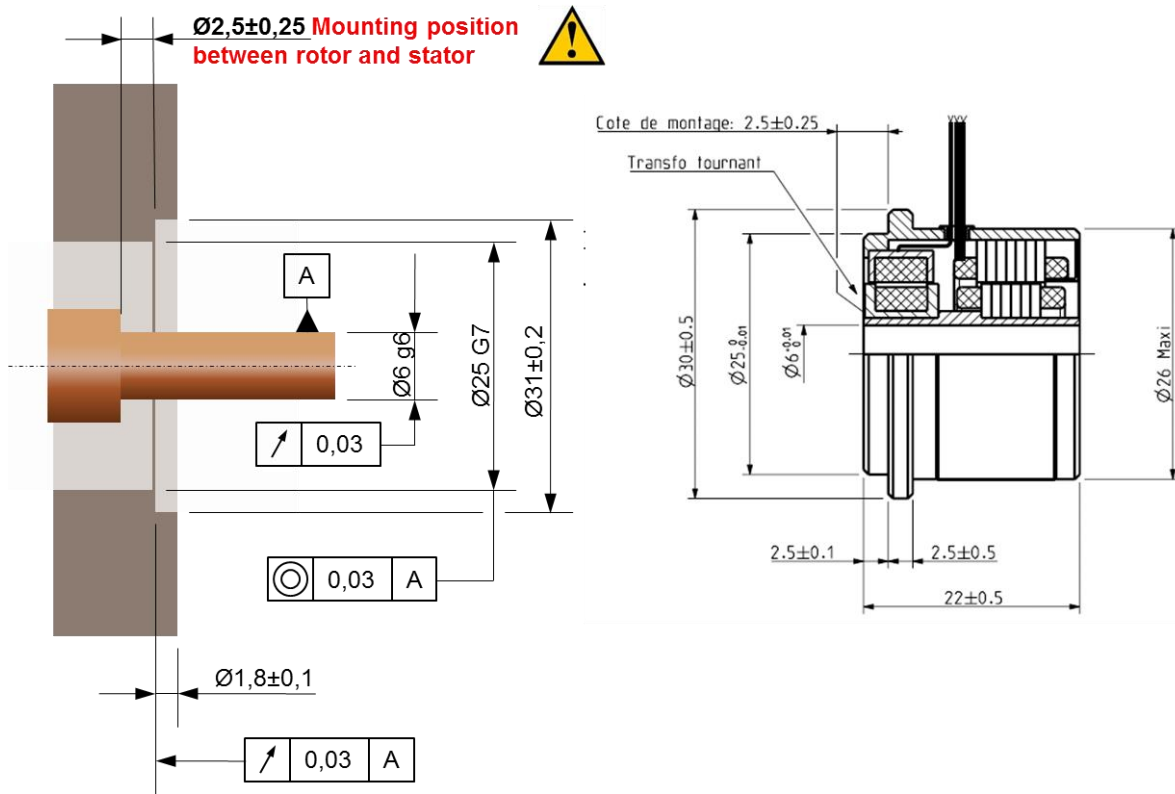

Resolver part number 220005P1001

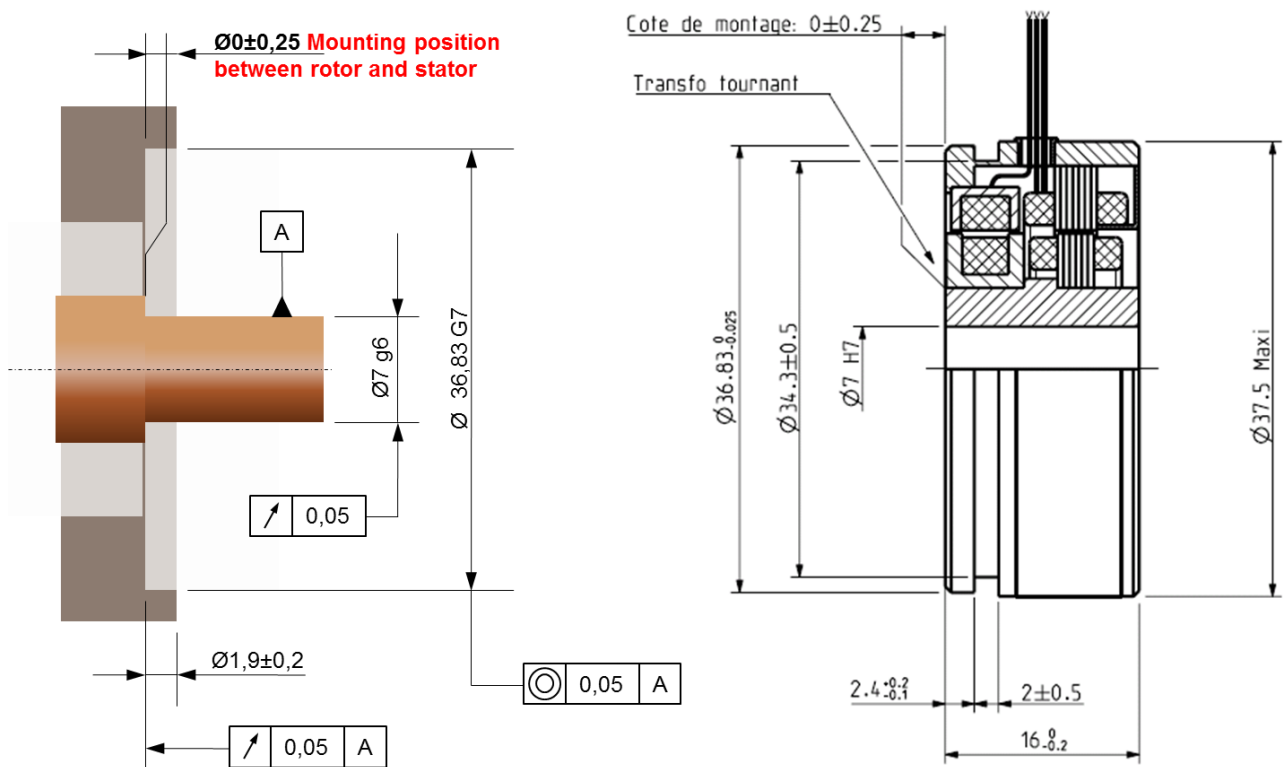

Resolver part number 220005P1002

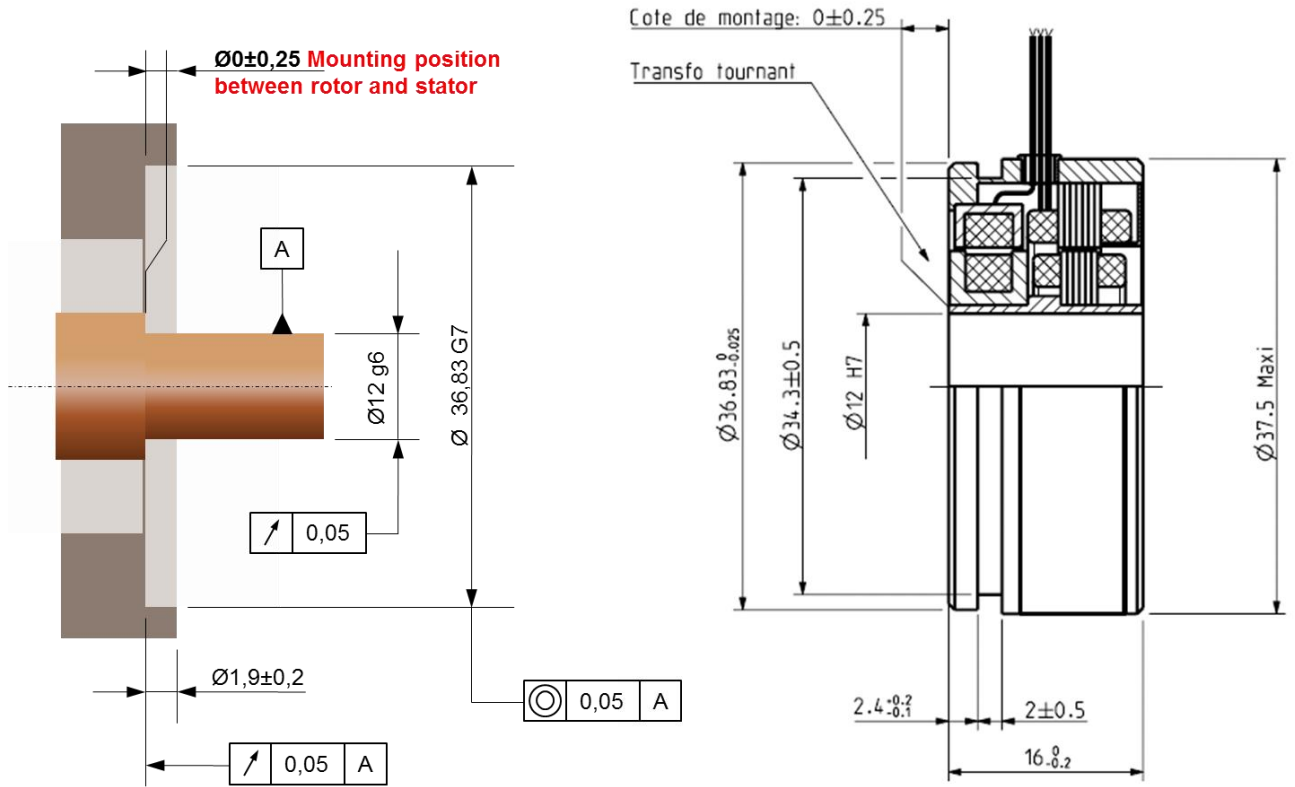

Resolver part number 22005P1003

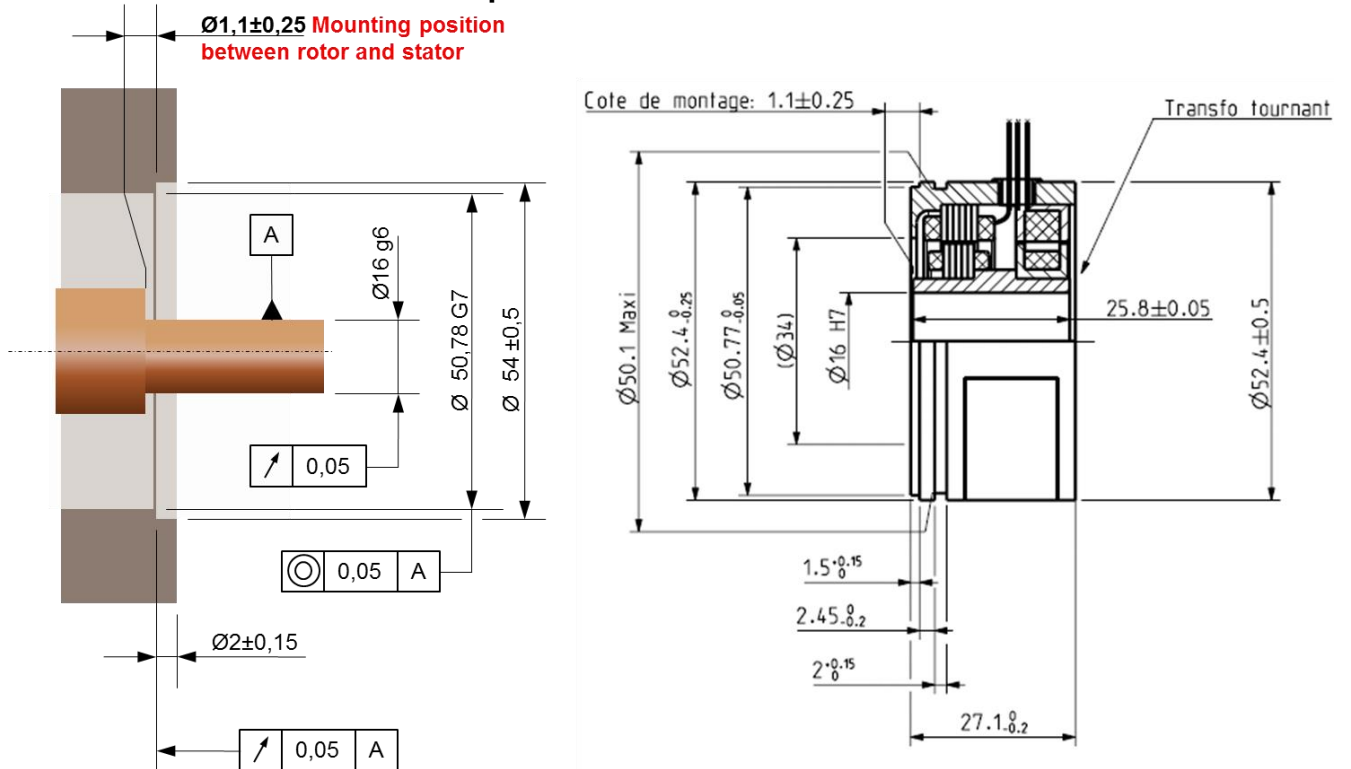

3.7.3. Encoder

Instead of a resolver we can provide an encoder:

- Incremental encoder
- Hiperface single turn or multiturn
- Endat, single turn or multiturn
- ...



4. COMMISSIONING, USE AND MAINTENANCE

4.1. Instructions for commissioning, use and maintenance

4.1.1. Equipment delivery

All kits are strictly controlled during manufacturing, before shipping. While receiving it, it is necessary to verify kit condition and if it has not been damaged in transit. Remove it carefully from its packaging. Verify that the data written on the label are the same as the ones on the acknowledgement of order, and that all documents or needed accessories for user are present in the packaging.



Warning: In case of damaged material during the transport, the recipient must **immediately** make reservations to the carrier through a registered mail within 24 h..

4.1.2. Handling

Kit motors are delivered in two part, rotor and stator divided.



DANGER: Do not handle the stator with the help of electrical cables or use any other inappropriate method. Use non-magnetic material to handle rotor.



Attention: Rotors have strong permanent magnets. It creates strong attraction forces that can crush fingers or hands. Firmly hold the rotor and move away all magnetic parts.





Caution: Clean the working area of all ferromagnetic part such as tools, screws, steel particles. Use wood table to work or make machine assembly.

4.1.3. Storage

Before being assembled, the kith has to be stored in a dry place, without rapid or important temperature variations in order to avoid condensation. During storage, the ambient temperature must be kept between -20 and +60°C. If the kit has to be stored for a long time, verify that the rotor and stator are coated with corrosion proof product.

4.2. Kit Integration

4.2.1. General warnings

	<p><u>Caution:</u> The integrator bears the entire responsibility for the preparation of the machine design.</p>
	<p><u>Danger</u> : The integrator must certify the motor by an approved organism to comply with all the regulations (CE, UL, ...) and perform all the mandatory routine tests (exemples : IEC60034...)</p>
	<p><u>Attention:</u> Rotor has strong permanent magnets. It creates strong attraction force that can crush fingers or hands. Firmly hold the rotor and move away all magnetic parts. <u>Caution:</u> Clean the working area of all ferromagnetic part such as tools, screws, steel particles. Use wood table to work or make machine assembly.</p>
	<p><u>Caution:</u> Anyone wearing pacemaker, hearing aid, watches, magnetic data storage device must keep at 1 meter from the kit.</p>
	<p><u>Caution:</u> Before assembling the kit, the surfaces must be cleaned.</p>

4.2.1. Tightening torque

The table below gives the average tightening torques required regarding the fixing screw diameter. These values are valid for both motor's feet and flange bolting.







Screw diameter	Tightening torque
M2 x 0.35	0.35 N.m
M2.5 x 0.4	0.6 N.m
M3 x 0.5	1.1 N.m
M3.5 x 0.6	1.7 N.m
M4 x 0.7	2.5 N.m
M5 x 0.8	5 N.m
M6 x 1	8.5 N.m
M7 x 1	14 N.m
M8 x 1.25	20 N.m

Screw diameter	Tightening torque
M9 x 1.25	31 N.m
M10 x 1.5	40 N.m
M11 x 1.5	56 N.m
M12 x 1.75	70 N.m
M14 x 2	111 N.m
M16 x 2	167 N.m
M18 x 2.5	228 N.m
M20 x 2.5	329 N.m
M22 x 2.5	437 N.m
M24 x 3	564 N.m



Warning: After 15 days, check all tightening torques on all screw and nuts.

4.3. Electrical connections

	<p><u>Danger:</u> Do not connect the kit to any electric supply . Only the motor can be connected to an electric supply.</p>
	<p><u>Danger:</u> never connect the motor to a drive with a DC bus higher than:</p> <ul style="list-style-type: none">- 155VDC for sizes 32, 44, 64 and 89- 340VDC for size 178.
	<p><u>Danger:</u> Check that the power to the electrical cabinet is off prior to making any connections.</p>
	<p><u>Caution:</u> The wiring must comply with the drive commissioning manual and with recommended cables. <u>Caution:</u> Section motor cable is lower than commissioning section cable between motor and drive due to high performance motor cable design. Do not take the same cable section than motor.</p>
	<p><u>Danger:</u> The kit must be earthed by connecting to an unpainted section of the motor.</p>
	<p><u>Caution:</u> The motor cables are designed for high current density, so cable surface can reach temperatures exceeding 100°C.</p>
	<p><u>Caution:</u> After 15 days, check all tightening torques on cable connection.</p>

Please, read §3.6 "Power Electrical connection" to have information about cable.

Many useful informations are already available in the drive documentations.

The motor must be connected to the servo amplifier according to the drive user manual. The color code given in the table must be followed :

Signal	Color
U	Red
V	Black
W	White



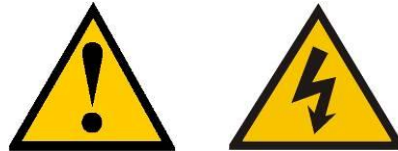

The kit is shipped without a ground cable. It is mandatory to connect a (green-yellow) ground cable between the motor frame and machine. The ground cable cross-section must be the same as the power cable cross-section



Before applying power:

- ✓ Check there is no damage on winding or cable due the mounting by a dielectric test
- ✓ Check all external wiring circuits of the system – power, control, motor and earth connections.
- ✓ Ensure that nobody is working on another part of the system who will be affected by powering up
- ✓ Ensure that other equipment will not be adversely affected by powering up.

4.4. Commutation sensor cable handling

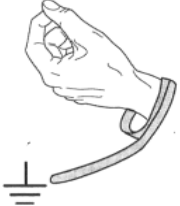
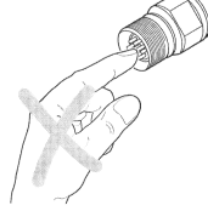
	<p><u>Danger:</u> before any intervention the drive must be stopped in accordance with the procedure.</p>
	<p><u>Caution:</u> It is forbidden to disconnect the Encoder cable under voltage (high risk of damage and sensor destruction).</p>
	<p><u>Attention:</u> Do not mix feedback wires with motor wires to avoid EMI (electromagnetic interference). EMI risk to set default the drive. So, careful to separate resolver and motor wires.</p>
	<p><u>Warning:</u> Always wear an antistatic wrist strap during encoder handling.</p>
	<p><u>Warning:</u> Do not touch encoder contacts (risk of damage due to electrostatic discharges ESD).</p>

4.5. Tests

The kit delivered by Parker are tested :

- dielectric test,
- surge test,
- winding resistance and inductance,
- direction of rotation,
- rotor flux.

But every complete motor must be tested for safety reason and to comply with the regulations (CE,...).

	<p>Danger : The integrator must certify the motor by an approved organism to comply with all the regulations (CE, UL, ...) and perform all the mandatory routine tests (exemples : IEC60034...).</p> <p>The typical process is the qualification of a complete unit and routine tests (including safety tests) on each unit produced</p>
---	---

Exemple of a summary of the recommended safety tests, to be validated by an approved organism.

Attention : other could be needed in accordance with regulations:

- **The continuity of the grounding circuit :**
On **each** complete motor , the resistance between any conductive point and the grounding conductor shall not exceed than 100mΩ. This test shall be performed before the dielectric tests. (EN60204-1: Safety of the machine)
- **Below exemples of dielectric tests performed on each complete unit (Sefelec SMG50 can be used).**

Dielectric Test	Motor U,V,W wires	Resolver wires	Hall effect sensor wires	Frame	Test duration, depends on power
Motor	700V for <100VAC (sizes 32, 44, 64 and 89) 1500V for 230 VAC (size 178)	Connected on Frame	Connected on Frame	0V	1min
Resolver	Connected on Frame	620V	N/A	0V	1s
Encoder	Check with encoder supplier for tests to be done				
...	...				

4.6. Troubleshooting

Some symptoms and their possible causes are listed below. This list is not comprehensive. Whenever an operating incident occurs, consult the relevant servo drive installation instructions (the troubleshooting display indications will help you in your investigation) or contact us at: <http://www.parker.com/eme/repairservice>.

<p>You note that the motor does not turn by hand when the motor is not connected to the drive.</p>	<ul style="list-style-type: none"> • Check there is no mechanical blockage or if the motor terminals are not short-circuited. • Check the power supply to the brake
<p>You have difficulty starting the motor or making it run</p>	<ul style="list-style-type: none"> • Check on the fuses, the voltage at the terminals (there could be an overload or the bearings could be jammed), also checks on the load current. • Check the power supply to the brake (+ 24 V \pm 10 %) and its polarity. • Check on any thermal protection, its connection and how it is set in the drive. • Check on the servomotor insulation (if in doubt, carry out hot and cold measurements). <p>The minimum insulation resistance value measured under a max. 50V DC is 50 MΩ:</p> <ul style="list-style-type: none"> • Between the phase and the casing • Between the thermal protection and the casing • Between the brake coil and the casing <ul style="list-style-type: none"> - Between the resolver coils and the casing.
<p>You find that the motor speed is drifting</p>	<ul style="list-style-type: none"> • Reset the offset of the servoamplifier after having given a zero instruction to the speed setpoint input.
<p>You notice that the motor is racing</p>	<ul style="list-style-type: none"> • Check the speed set-point of the servo drive. • Check you are well and truly in speed regulation (and not in torque regulation). • Check the encoder setting • Check on the servomotor phase order: U, V, W
<p>You notice vibrations</p>	<ul style="list-style-type: none"> • Check the encoder and tachometer connections, the earth connections (carefully) and the earthing of the earth wire, the setting of the servo drive speed loop, tachometer screening and filtering. • Check the stability of the secondary voltages. • Check the rigidity of the frame and motor support.
<p>You think the motor is becoming unusually hot</p>	<ul style="list-style-type: none"> • It may be overloaded or the rotation speed is too low : check the current and the operating cycle of the torque motor • Check if the mounting surface is enough or if this surface is not a heat source – see §3.5 Natural cooled motor. • Friction in the machine may be too high : <ul style="list-style-type: none"> - Test the motor current with and without a load. - Check the motor does not have thermal insulation.



<p>You find that the motor is too noisy</p>	<p>Several possible explanations :</p> <ul style="list-style-type: none">• Unsatisfactory mechanical balancing• There is friction from the brake: mechanical jamming.• Defective coupling• Loosening of several pieces• Poor adjustment of servo drive or position loop : check rotation in open loop
---	---